



Nexera™ Reducing Sugar Analysis System

Reliable Reducing Sugar Analysis for All Laboratories



The Nexera reducing sugar analysis system uses Shimadzu's unique post-column boric acid-arginine fluorescence derivatization method. This system reduces the effects of impurities and offers both high sensitivity and a wide dynamic range. As a result, sugars contained in samples can be analyzed simultaneously, without any dilution even in the case of significant concentration differences.

■ Unique Detection Method Provides Excellent Quantitative Reliability

This system uses a post-column fluorescence derivatization reaction using arginine as a reaction reagent and supports sugar analysis with high sensitivity and high-selectivity.

■ Compatible with Different Separation Mode

This system is compatible with a wide range of separation modes used for sugar analysis.

■ Analytical Intelligence Reduces the Analysis Cost

The FlowPilot functionality increases the flow rate gradually to the method set point according to the status of the column oven, extending the life of your columns.

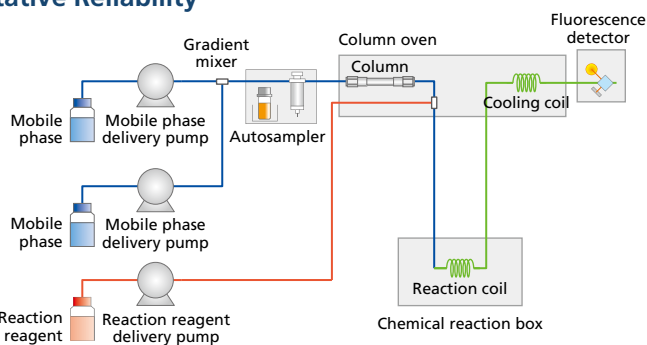

Flow-line Diagram for the Nexera Reducing Sugar Analysis System

Unique Detection Method Provides Excellent Quantitative Performance

High Sensitivity Analysis of Sugars

The analysis of low concentration sugars, which was difficult with conventional refractive index detectors, can now be performed by the reducing sugar analysis system. Additionally, this detection method offers a wide dynamic range resulting the ideal solution for the accurate quantitation of samples with large concentration differences.

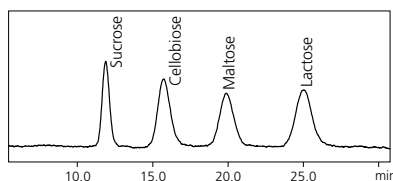

Analysis of a Standard Mixture of Sugars
(0.005 μmol/mL, 10 μL injection)

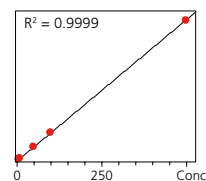

Glucose Linearity
(0.005 μmol/mL to 1 μmol/L, 10 μL injection)

Highly Selective Detection of Reducing Sugars

Fermented food are extremely heterogenous compounds, and sugars can be difficult to analyze due to the presence of different substances. The system using Shim-pack™ ISA-09 allows you to carry out highly-selective analysis of reducing sugars by eliminating the risk signal cross-contamination.

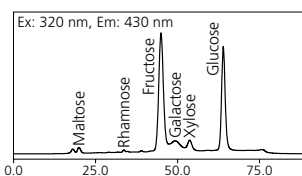

Chromatogram of Red Wine
(10 μL injection)

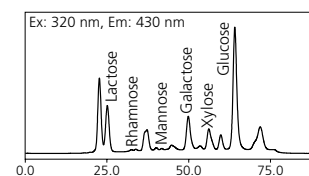

Chromatogram of Vinegar
(10 μL injection)

Compatible with Different Separation Modes

Sugars are highly hydrophilic compounds, so anion exchange chromatography and ligand exchange chromatography are used rather than reversed phase chromatography which separates compounds via hydrophobicity interactions. The separation mode must be selected to suit the analytical purpose. The Nexera Reducing Sugar Analysis System allows the user to select among a variety of chromatographic conditions.

Sugar Separation by Borate Complex–Anion Exchange Chromatography

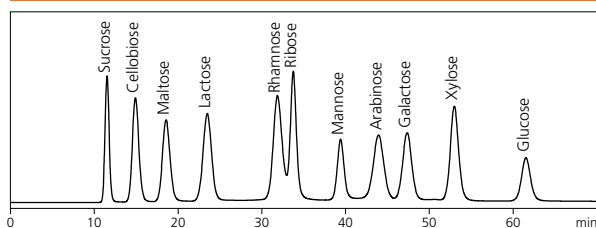

Analysis of a Standard Mixture of Sugars Using Shim-pack ISA-09 (0.5 μmol/mL (5 μmol/mL Sucrose), 10 μL injection)

Sugar Separation by Ligand Exchange Chromatography

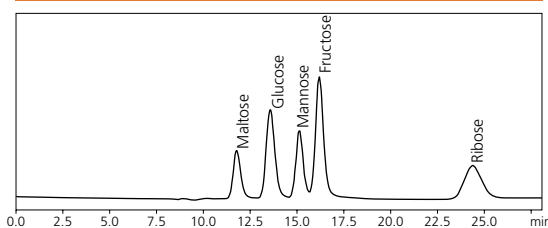

Analysis of a Standard Mixture of Sugars Using Shim-pack SCR-101C (0.5 μmol/mL, 10 μL injection)

Analytical Intelligence Reduces the Analysis Cost



HPLC columns can be damaged by sudden pump starts and stops or extreme gradient changes. The Nexera automatically uses FlowPilot (Smart Flow Control) to increase the flow rate gradually to the set point. There is no need to create startup protocols for each analysis.



Automated support functions utilizing digital technology, such as M2M, IoT, and Artificial Intelligence (AI), that enable higher productivity and maximum reliability. Allows a system to monitor and diagnose itself, handle any issues during data acquisition without user input, and automatically behave as if it were operated by an expert. Supports the acquisition of high quality, reproducible data regardless of an operator's skill level for both routine and demanding applications.

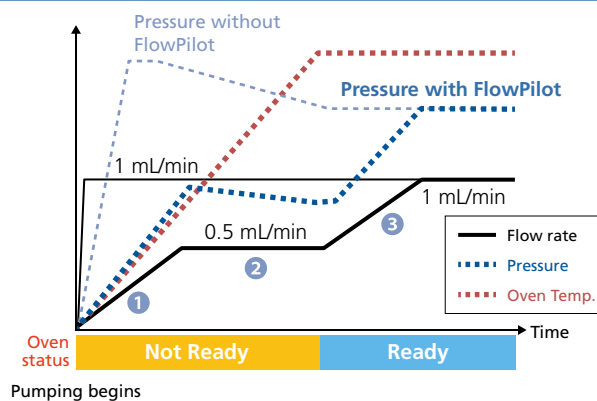

Analytical Columns

Borate Complex–Anion Exchange Column

The Shim-pack ISA-09 column uses the property of sugar to form a complex with boric acid and separates this in anion exchange mode. Monosaccharides and disaccharides are separated simultaneously with a gradient in which boric acid buffer solutions at two different concentrations are used as the mobile phase.

Item	Length (mm)	I.D. (mm)	P/N
Shim-pack ISA-09	250	4.0	228-59512-41
Shim-pack ISA-09 (G)	50	4.0	228-59512-42

Gel Filtration–Ligand Exchange Column

The Shim-pack SCR series columns are for ligand exchange chromatography and use the property of some metallic ions to form complexes with sugars. Water is used as the mobile phase, but anomer separation can be seen when running the analysis at low temperatures. High temperature (≥ 60 °C) is recommended to avoid this phenomenon.

Item	Length (mm)	I.D. (mm)	P/N
Shim-pack SCR-101N	300	7.9	228-07730-92
Shim-pack SCR-101C	300	7.9	228-17889-91
Shim-pack SCR-101P	300	7.9	228-17890-91
Guard column SCR(N)	50	4.0	228-09619-92
Guard column SCR(C)	50	4.0	228-17891-91
Guard column SCR(P)	50	4.0	228-17892-91

Nexera, Analytical Intelligence logo and Shim-pack are trademarks of Shimadzu Corporation or its affiliated companies in Japan and/or other countries.



Shimadzu Corporation

www.shimadzu.com/an/

For Research Use Only. Not for use in diagnostic procedures.

This publication may contain references to products that are not available in your country. Please contact us to check the availability of these products in your country.

Company names, products/service names and logos used in this publication are trademarks and trade names of Shimadzu Corporation, its subsidiaries or its affiliates, whether or not they are used with trademark symbol "TM" or "®".

Third-party trademarks and trade names may be used in this publication to refer to either the entities or their products/services, whether or not they are used with trademark symbol "TM" or "®".

Shimadzu disclaims any proprietary interest in trademarks and trade names other than its own.

The contents of this publication are provided to you "as is" without warranty of any kind, and are subject to change without notice. Shimadzu does not assume any responsibility or liability for any damage, whether direct or indirect, relating to the use of this publication.