

LC World Talk

SHIMADZU'S NEWSLETTER FOR THE HPLC GLOBAL COMMUNITY



Prominence UFLCXR —
Progressing toward more effective performance

LC Driver for Empower™ Software

Prominence nano —
Nano HPLC for high-precision proteome analysis

Interactive LC Virtual Advisor—
And now available: LCMS Virtual Advisor



PROMINENCE UFLCXR

–Progressing toward more effective performance

Pressure tolerance up to 66 MPa allows a wider variety of applications for ultra fast HPLC

In the past few years, high-speed and high-efficiency separations have become the focus of attention for many researchers and chromatographers. In response, Shimadzu introduced the Shim-pack XR-ODS columns, which have 2.2 μ m particles, to enable users to shorten analysis time drastically without high pressure, while maintaining high separation efficiency. Prominence UFLC with the XR-ODS columns offers true ultra fast liquid chromatography analysis, while maintaining high analysis accuracy and reliability, as mentioned in the past two *LC WorldTalk* issues.

However, achieving greater analysis speed is not the sole issue. Equally important is the issue of resolution, or the ability to perform analysis without degradation in the quality of the data. As a result, Shimadzu recently developed the Prominence UFLCXR system, which achieves enriched data information by means of higher separation performance. Prominence UFLCXR allows the usage of high pressure conditions (maximum: 66MPa, 9570psi), which enables use of a longer column with sub-3 μ m particles to obtain higher separation efficiency.

Shimadzu's aim has been to make high-speed analysis compatible with high resolution, not simply to perform high-speed analysis with a smaller particle-sized column (Figure 1). By maintaining the high analysis accuracy and reliability cultivated with the Prominence series, the Prominence UFLCXR satisfies the demands for an ultra-fast high-resolution HPLC system that have been increasing in many HPLC application fields where analytical throughput or productivity is the issue.

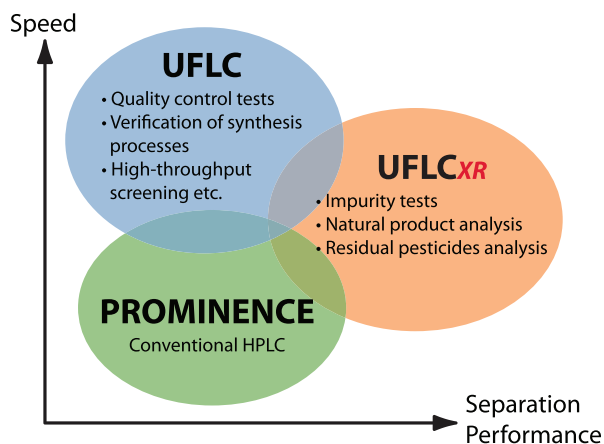
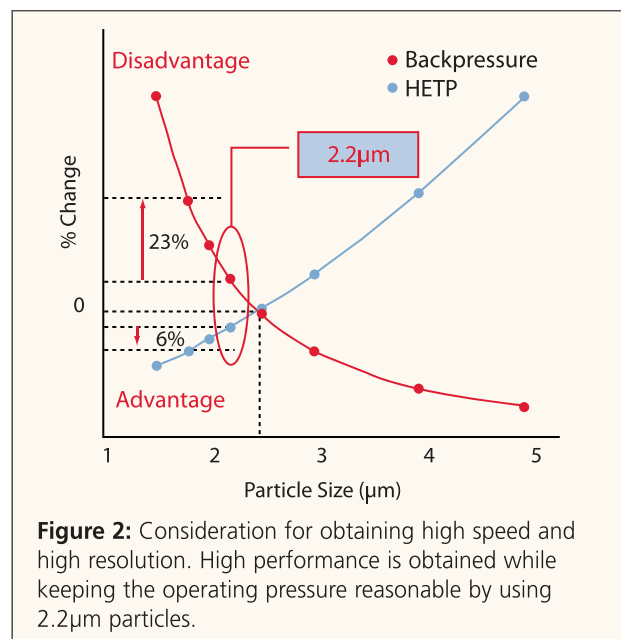

Figure 1: Application area of Prominence UFLCXR



Prominence UFLCXR
ULTRA FAST LIQUID CHROMATOGRAPH



Ultimate Separation Performance

As seen in Figure 2, the column pressure (red line) drastically increases as the particle size decreases, while the improvement of separation efficiency (blue line) is minimal, especially in smaller particles. Consequently, the separation performance of a 2.2 μ m particle column is not very different from that of a 1.8 μ m column, but the expected back pressure is greatly reduced. Use of the Shim-pack XR-ODS column provides a pressure that is less than half of a commercially available 1.8 μ m column. In the Spring 2007 issue of *LC WorldTalk*, we mentioned that the Prominence UFLC with the XR-ODS columns enables users to efficiently shorten analysis time without extremely high pressure, while maintaining high separation efficiency and excellent system performance features, such as reproducibility, carryover and durability.

Shim-pack XR-ODS II

ID	Length	Max. Press	Pore size
2mm	75 100 150mm	60MPa	8nm
3mm	75 100 150mm	60MPa	8nm

Shim-pack XR-ODS

ID	Length	Max. Press	Pore size
2mm	30, 50, 75, 100mm	30MPa	12nm
3mm	30, 50, 75, 100mm	30MPa	12nm
4.6mm	30, 50, 75, 100mm	30MPa	12nm

Table 1: Lineup and specifications of Shim-pack XR-ODSII and XR-ODS

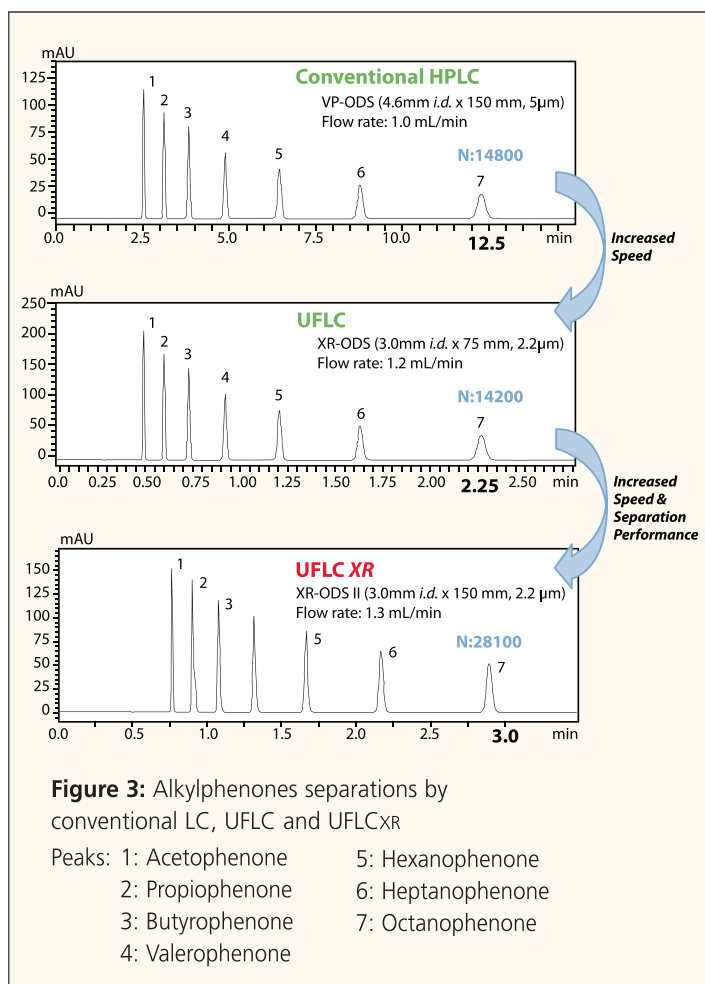

The Prominence UFLCXR is a continuation of this progress. Prominence UFLCXR features ultra-high-speed, high-resolution analysis with superior repeatability, low sample carryover and high sensitivity under high-pressure conditions (maximum allowable pressure: 66MPa). The Prominence UFLCXR system consists of the new solvent delivery unit, LC-20ADXR, and new autosampler, SIL-20AXR, which expanded the maximum pressure to 66MPa, and existing Prominence UFLC units.

The Shim-pack XR-ODSII 2.2µm column series, released simultaneously, has a higher pressure tolerance (maximum: 60 MPa) than the XR-ODS columns, and a 150mm length column for ultra-high separation was added to the lineup (Table 1).

Figure 3 shows separations of alkylphenones performed using three Prominence systems: conventional Prominence HPLC with Shim-pack VP-ODS column (5µm particles), Prominence UFLC with Shim-pack XR-ODS (2.2µm particles) and Prominence UFLCXR with Shim-pack XR-ODSII (2.2µm particles).

By using 2.2µm particles and Prominence UFLC, the analysis time was five times faster than that of 5µm particles. The results obtained on the Prominence UFLCXR system with a Shim-pack XR ODSII column are shown as the bottom chromatogram in Figure 3. The theoretical plate increased to 28,000 by using a 150mm length column in a mere three minutes. Prominence UFLCXR and XR-ODSII, exhibiting increased pressure tolerance, offer the ultimate separation performance.

Excellent Reproducibility and Low Sample Carryover

Of the basic performance specifications required of analytical instruments, high reproducibility and low sample carryover are essential for high-resolution, high-sensitivity analysis. With the Prominence series, these needs were addressed at an early stage, and superior technology was cultivated for all the fundamental elements. This technology includes a high-performance pump, an autosampler capable of a high level of injection reproducibility, even for minute quantities, and an injection mechanism that prevents sample carryover. These technologies have all been inherited by the Prominence UFLCXR, and support high-resolution, high-sensitivity analysis.

The SIL-20AXR autosampler has a metal-coated needle, and a needle seal with optimized materials based on the technologies cultivated in the development of the Prominence series. The sample contact area between the needle and needle seal is minimized by reducing dead space, allowing sample carryover to be minimized. Additionally, the SIL-20AXR has a new high-pressure valve design which reduces the internal volume and has high-pressure tolerance. The SIL-20AXR uses the direct injection method (total-volume injection method), in which the mobile phase passes through the interior of the sample needle, washing out adsorptive components. This makes it possible to attain excellent reproducibility of 0.3% RSD or less, even with the injection of minute quantities (Table 2).

Injection volume	Peak Area	
	Average	%RSD
1µL	37596	0.148
2µL	75249	0.097
5µL	188382	0.026
10µL	375846	0.021

Table 2: Peak area reproducibility – sample: caffeine 20µg/mL; Pressure: 50 MPa; n = 6

Carryover of a strong basic compound and a neutral compound in the autosampler were evaluated using the Prominence UFLCXR system (Figure 4). With chlorhexidine, which is generally known for causing serious carryover issues due to its basic nature, only very slight carryover (0.00046%) was observed – without an extra rinse process. Only an instantaneous dip of the needle into a rinse solution was used. Carryover of the caffeine sample was not observed, even without rinsing of the needle's outer surface (under 46MPa and 66MPa backpressure conditions).

Carryover for reserpine was evaluated using LC-MS/MS (API-5000) as a detector. As shown in Figure 5, the carryover for reserpine was only 0.000161%, even without a rinse. Moreover, the carryover wasn't seen at all when optional rinsing of the needle by two solvents was performed.

These results prove the SIL-20AXR autosampler possesses a superior ability to reduce carryover and is well-suited for the analysis of trace compounds with MS.



Figure 4A/B: Results of carryover tests when using a neutral and basic compound

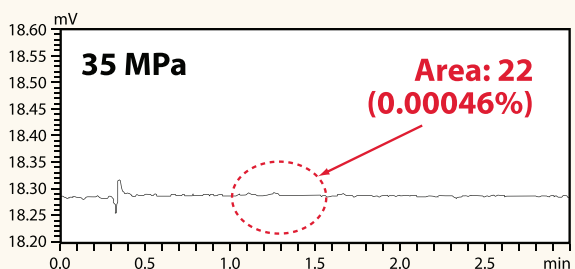
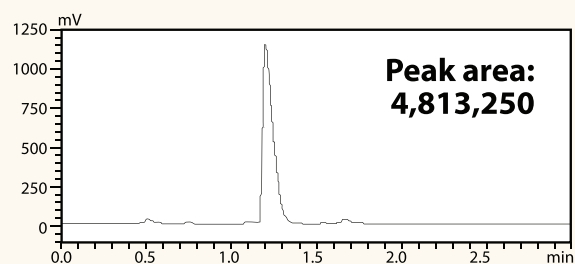

A: Basic compound: Chlorhexidine hydrochloride
Injection volume: 5µL
Rinse mode: Rinse before and after aspiration of sample *1)
Rinse solution: 0.05% formic acid in MeOH
 *1) Instantaneous dip of the injection needle into rinse solution

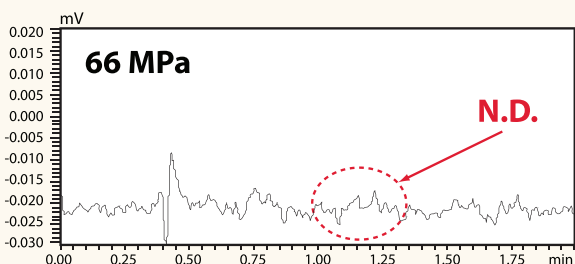
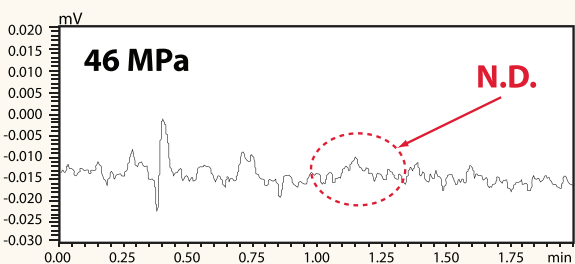
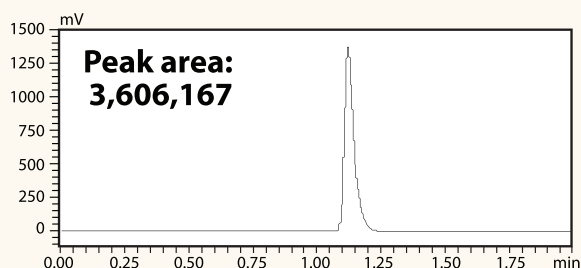

B: Neutral compound: Caffeine 500 mg/L
Injection volume: 10µL
Rinse mode: No rinsing

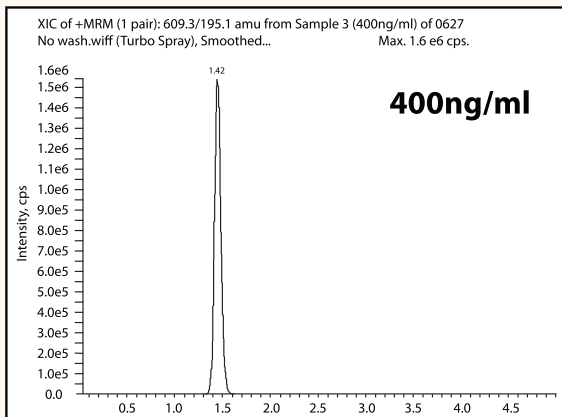

400ng/ml

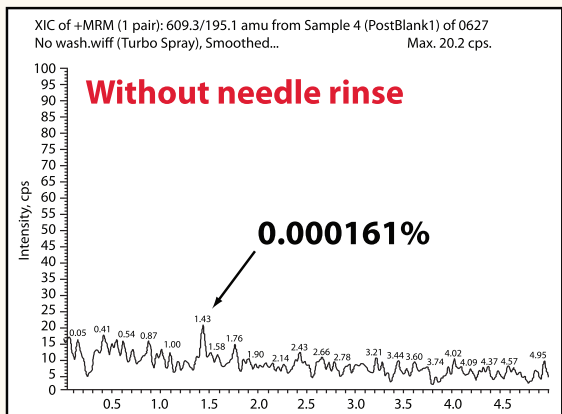

Without needle rinse

0.000161%

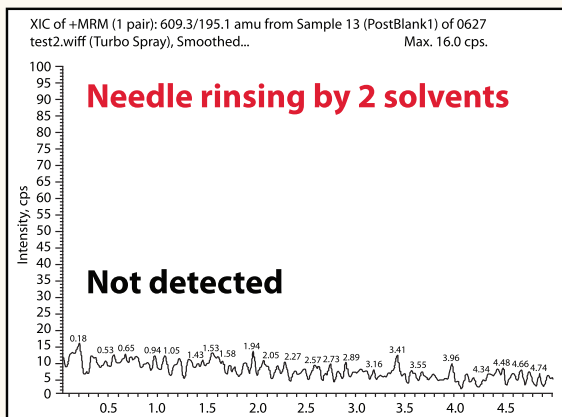

Needle rinsing by 2 solvents

Not detected

Figure 5: Carryover evaluation of Prominence UFLCXR by LC-MS/MS (API-5000) detection

Test compound: Reserpine
Evaluation method: 40ng/mL reserpine injection →
 400ng/mL reserpine injection →
 blank injection
Injection volume: 3μL
Rinse setting
Rinse solvent: Acetonitrile (for dipping needle)
Additional rinse solvents: Acetonitrile: isopropanol (=8:2) and 0.5% formic acid
Rinse mode: Before and after aspiration
Rinse method: 3: rinse pump then port
Detection: API-5000
Scan type: MRM

In the case of gradient elution, reproducibility of retention time depends on the mixing accuracy of mobile phases. Steep gradients, which are often performed on fast HPLC, influence gradient precision, and cause considerable variations of retention time. In the Prominence UFLCXR system, the minimum steps of gradient control were optimized for ultra-fast HPLC, enabling it to deliver an accurate gradient profile, even for short cycle gradients.

The results of an alkylphenones analysis indicated that the reproducibility of the retention times was improved to approximately 0.1% RSD using the modified gradient control firmware as shown in Figure 6. This result shows the modification of gradient control is effective for improving the reproducibility quality of ultra-fast analysis.

High-Sensitivity Detection of Trace Components

The combination of the Prominence UFLCXR and a Shim-pack XR-ODS II column achieves a level of separation performance equivalent to that of at least a 250-mm column with 5μm particles. The wide dynamic range of

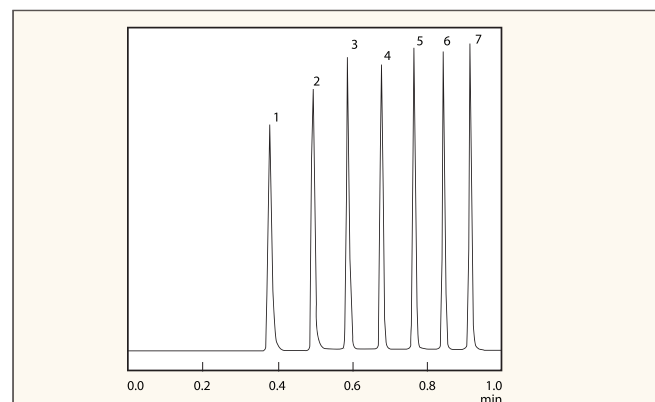

Compounds	Gradient step	
	Fast LC mode	Normal LC mode
1 Acetophenone	0.199%	0.239%
2 Propiophenone	0.146%	0.255%
3 Butyrophenone	0.119%	0.252%
4 Valerophenone	0.066%	0.245%
5 Hexanophenone	0.097%	0.222%
6 Heptanophenone	0.089%	0.204%
7 Octanophenone	0.102%	0.218%

Figure 6/ Table 3: Reproducibility of retention time on ultra-fast gradient (%RSD: n = 6)

Chromatographic conditions

Column: Shim-pack XR-ODS (3 mmI.D. x 50 mmL., 2.2μm)
Mobile phase: A: water, B: acetonitrile
Gradient: 50% B to 100% B (0.0 to 0.55 min.), 100% B (0.55 to 0.7 min.), 50% B (0.71 to 2 min.)
Flow rate: 1.5 mL/min
Temperature: 40 °C
Detection: Absorbance at 245 nm
Sample: Alkylphenones

the SPD-20A detector enables high-separation, high-sensitivity detection of fine peaks, such as those obtained for minute quantities of impurities in pharmaceuticals, and thereby enables highly reliable analysis in which the slightest presence of impurities is detected. Also, the low-carryover feature of the SIL-20AXR autosampler supports high-accuracy analysis.

The results obtained in the analysis of a minute quantity of an impurity in cefazolin are shown in Figure 7. This impurity was sufficiently separated from other impurities and, although its peak was only one-thousandth the height of the peak obtained for the main component, the wide dynamic range ensured that it was detected properly.

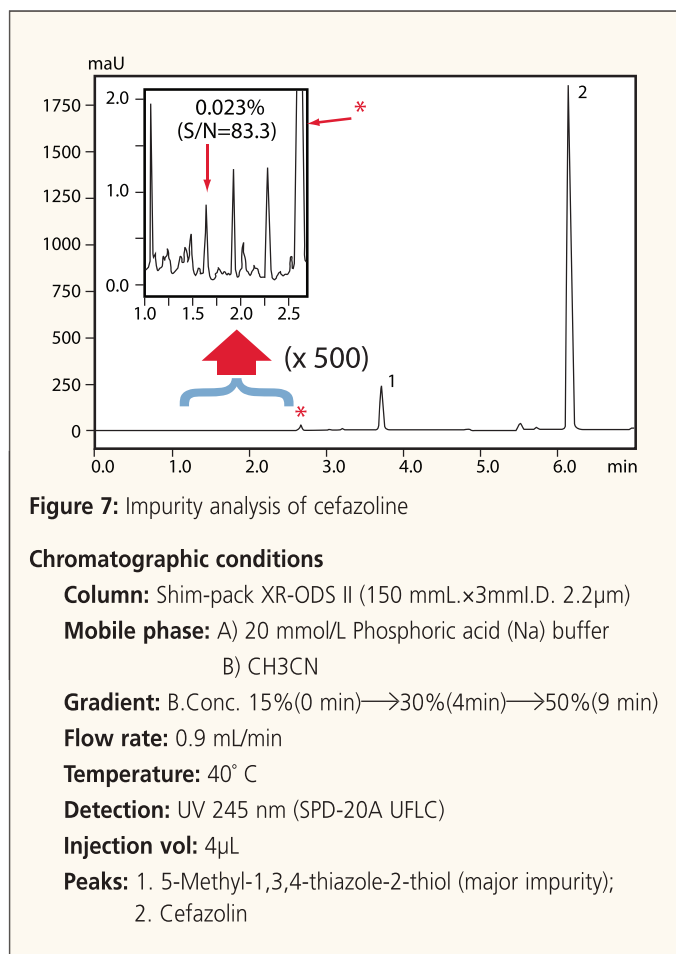

Applicable to a wider range of applications

Prominence UFLCXR enables the use of a longer column with smaller particles, methanol mobile phases and ambient temperature conditions. As a result, Prominence UFLCXR is applicable for a wider range of applications due to the increased pressure tolerance.

Figure 8 shows chromatograms of aldehydes and ketones obtained by Prominence UFLCXR and Prominence UFLC. In comparison with Prominence UFLC, Prominence UFLCXR (top chromatogram) achieved a superior separation in roughly the same analysis time required for Prominence UFLC.

Figure 9 shows a UFLCXR analysis of food additives with a mobile phase containing methanol. The column pressure was approximately 43MPa when a 3mmI.D.x75mm XR-ODSII column was used at a 1mL/min flow rate.

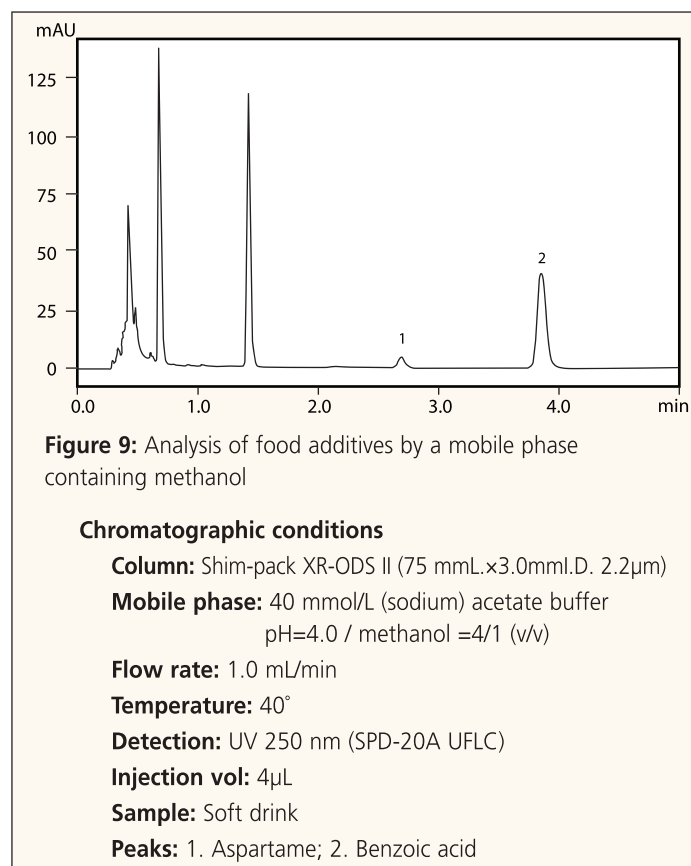
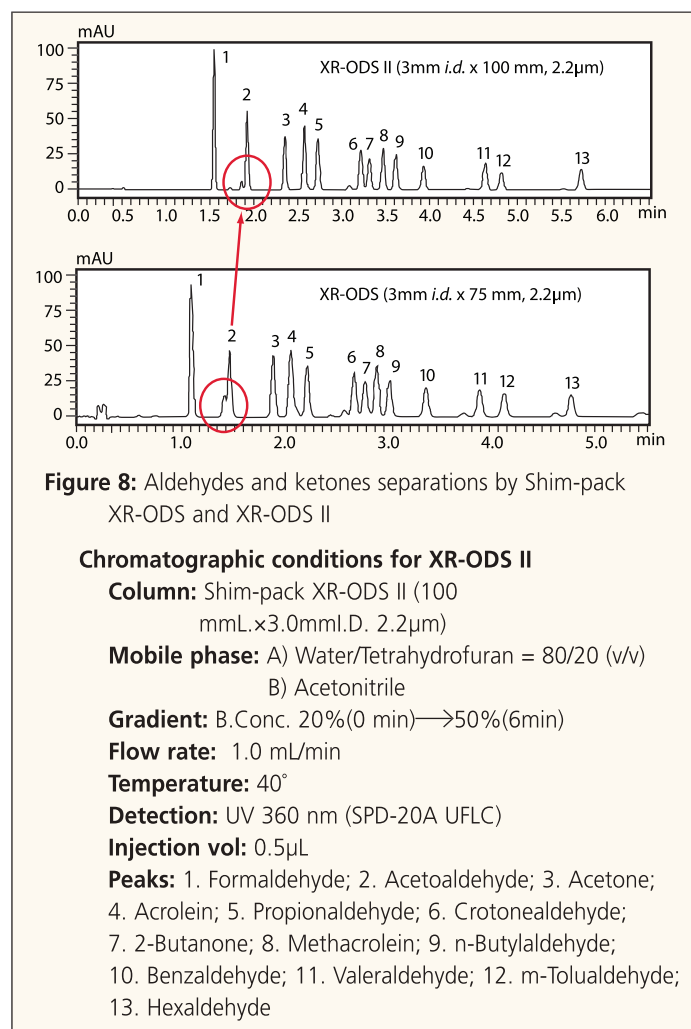

The chromatogram obtained by performing the high-separation analysis of polycyclic aromatics using the Prominence UFLCXR and the XR-ODS II is shown in Figure 10. With conventional LC, the resolution, R_s , for isomers of benzo[fluoranthene] was 1.25 and the analysis time was approximately 50 minutes, whereas with the Prominence UFLCXR, the R_s was significantly increased to 2.12 and the analysis time was reduced by approximately half. One often overlooked advantage of increased speed is reduced consumption of mobile phase.

The results obtained by analyzing the catechins in green tea using a water/acetonitrile mobile phase and a water/methanol mobile phase are shown in Figure 11. The separation selectivity for the components differs between the methanol and acetonitrile mobile phase. This example illustrates how the Prominence UFLCXR helps increase the range of available analysis methods, a feature that is useful for method development.

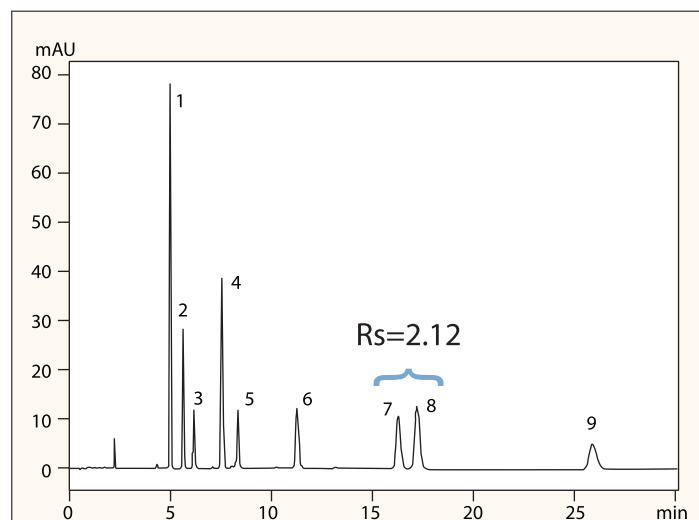

Figure 10: Analysis of a mixture of 9 polycyclic aromatic compounds

Chromatographic conditions

Column: Shim-pack XR-ODS II (150 mmL.x3.0mmL.D. 2.2 μ m)

Mobile phase: Water/Acetonitrile =35/65 (v/v)

Flow rate: 0.9mL/min

Temperature: 40°

Detection: UV 254 nm (SPD-20A UFLC)

Injection vol: 4 μ L

Peaks: 1. Fluorene; 2. Phenanthrene; 3. Anthracene; 4. Fluoranthene; 5. Pyrene; 6. Chrysene; 7. Benzo (b) fluoranthene; 8. Benzo (k) fluoranthene; 9. Benzo (g,h,k) perylene

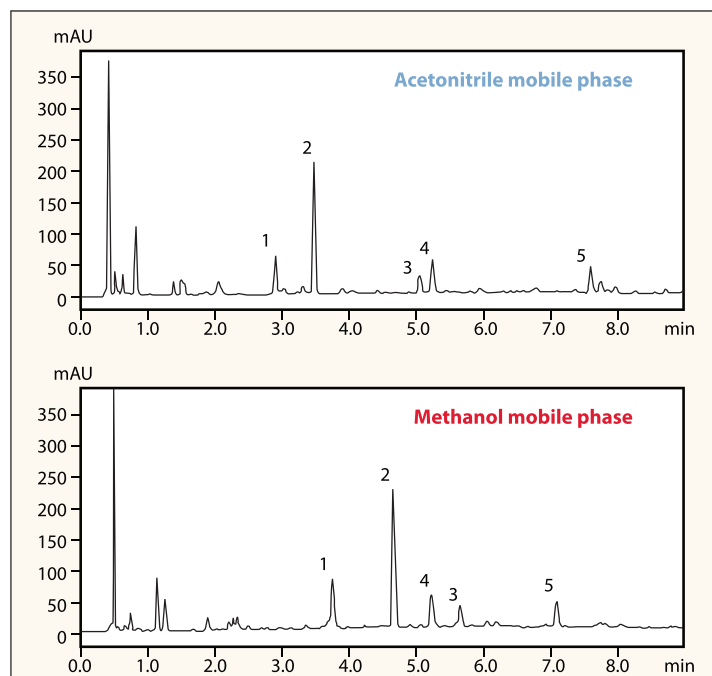

Figure 11: Analysis of catechins in green tea

Chromatographic conditions

Column: Shim-pack XR-ODS II (75 mmL.x3.0mmL.D. 2.2 μ m)

Mobile phase:

Upper:

A) 10mmol/L (sodium) phosphate buffer pH 2.6

B) A / acetonitrile =1/1 (v/v)

B.Conc: 10% (0min)→20% (4min)→40% (9min)

Lower:

A) 10mmol/L (sodium) phosphate buffer pH 2.6

B) A / methanol =1/2 (v/v)

B.Conc: 10% (0min)→30% (4min)→60% (9min)

Flow rate: 1.0mL/min

Temperature: 40°

Detection: UV 230 nm (SPD-20A UFLC)

Injection vol: 4 μ L

Peaks: 1. Epigallocatechin; 2. Caffeine; 3. Epicatechin; 4. Epigallocatechin gallate; 5. Epicatechin gallate

Conclusion

Over the last few years, the demands for ultra-fast HPLC have significantly increased in many application areas. And while manufacturers have kept pace with this demand, the ability to develop instruments that maintain the quality of the data or basic performance features, such as reproducibility and low carryover, under ultra-high-pressure conditions has been a challenge.

With the Prominence UFLCXR, that challenge has been addressed. Meeting Shimadzu's stringent QA/QC standards, Prominence UFLCXR delivers data with high integrity and reproducibility, achieving high speed, high precision, low carryover and good linearity — all at the same time. While fast chromatography at reasonable pressures is the most robust solution for generating highly reproducible data, which the Prominence UFLC accomplishes, when presented with a unique challenge that demands the use of longer columns for extra resolution, your answer is the Prominence UFLCXR. 

Features of the Shimadzu Empower™ Driver Relevant to 21 CFR Part 11 Compliance

Shimadzu HPLC can be fully configured and easily controlled using Empower™ or Empower2™ software by means of the Shimadzu Empower Driver, which seamlessly integrates LC-20A (Prominence and Prominence UFLC/XR) and LC-2010 Liquid Chromatographs by communicating directly with the Shimadzu System Controller (CBM) via an RS-232 or TCP/IP connections. The other controlled HPLC modules are connected to the CBM via fiber optical cables as usual with all Shimadzu systems. This setup provides a high level of software-hardware integration, which assists in compliance with 21 CFR Part 11. The data is acquired digitally. The acquisition method(s) and run sequence(s) are set in Empower using original Empower Sample and Method Sets. When Empower connects to the Shimadzu system it records the module serial number and later associates it with the data. The Empower Message Center displays and stores all error messages generated by Shimadzu hardware for easy troubleshooting. All Empower Audit Trails are available for use with Shimadzu systems.

A Shimadzu system controlled by Empower software meets all of the technical requirements of Part 11 for electronic records and signatures. The following is an overview of how a system assists in compliance in various technical aspects of the regulation.

System Validation

Shimadzu has extensively validated the Empower Driver and insured its accuracy, reliability and consistent performance. Detailed manuals, pre-installation and installation instructions, IQOQ, version documents as well as training materials are available for users.

Copies of Records

All of the individual data and metadata elements (such as Sample ID, Sample Name, Operator ID, etc.) that are captured by the Empower software and stored and access-controlled in the Oracle database are available when Empower is used in conjunction with the Shimadzu Driver. Accurate and complete records can be copied electronically or printed using Empower software.

Record Retention Period

Protection of records to enable their accurate and ready retrieval throughout the records retention period is a post-acquisition function that is handled entirely by the Empower Software.

System Access

Shimadzu Driver is fully integrated into the Empower software, which assures limited user access via the use of user IDs and passwords. Screens relevant to the Shimadzu Driver are only accessible from within the Empower

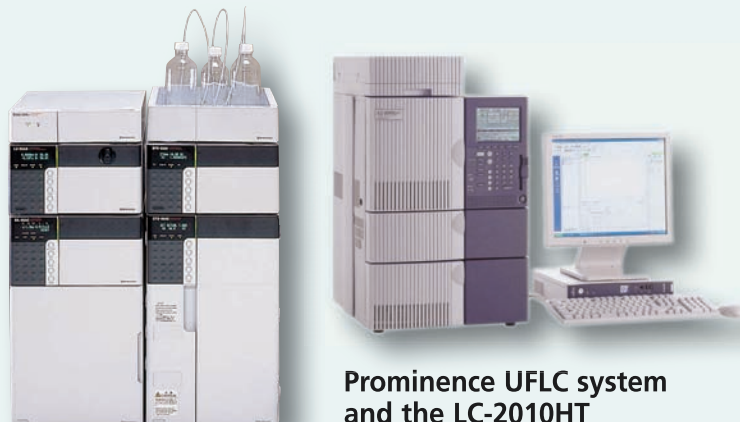

Prominence UFLC system and the LC-2010HT

application and, thus, protected by the Empower security mechanism. The Admin is capable of authorizing users and establishing initial passwords and password controls, such as password length, change interval, complexity, etc. The system does not accept redundant user IDs. User IDs can be inactivated and reactivated but cannot be deleted. The common name of the user is linked to the user ID. User access to application functions is further controlled by configurable individual privileges. Access control changes under the Admin menu are recorded in a log that is not changeable by the application Admin. Users are capable of changing their own passwords.

Audit Trails

Empower system policy prohibits overwriting of data, method, and sample set information from which a report is generated. A unique identification is assigned to each data point at the database level, insuring no record is overwritten. Every data point is associated with a date/time stamp, operator name, instrument, and substantial additional identifying information. Audit trails are created at the database level on actions that create, modify, or delete records and are not accessible for alteration by users or Admin. All event logs retain links to the acquisition/analysis data by date when data association or selection is maintained in the archival process.

Sequencing of Steps

The data acquisition and the order of samples are defined by the method and sample set in the Empower software. These controls supersede local instrument settings when Empower software is controlling the instrument via the Shimadzu Driver. The sample set established for a specific run enforces the sample order. The system enforces required fields and default values. The method and sample sets are linked with the data in the Empower database. ☒

Empower is a trademark of Waters Corporation.

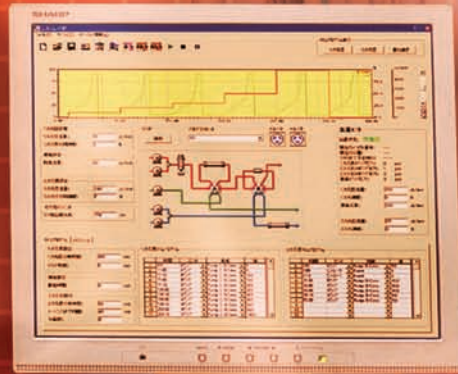

Prominence nano:

Nano HPLC for high-precision proteome analysis



Front-end HPLC Supporting High Precision Proteome Analysis

Proteome analysis, an exhaustive analytical technique for analyzing proteins, is primarily conducted using ESI-LCMS or MALDI-TOFMS. Many proteins and peptides are extremely minute in quantity, requiring the enhanced sensitivity provided by mass spectrometers. In the proteome fields, scale-down technology such as nano-flow and micro-flow has been required to improve ESI-MS sensitivity. MALDI methodology also requires flow rates less than 1 $\mu\text{L}/\text{min}$ for off-line connection to HPLC using a spotting device. Therefore, nano-flow HPLC is a key technology in proteome analysis in biochemical, medical science and pharmaceutical fields.

Apparent sensitivity is inversely proportional to the square of column internal diameter. Improvement of mass sensitivity can be expected by the scale-down of the HPLC flow system as shown in Figure 1.

Scale	column I.D.	Flow rate	Estimated Sensitivity ration (Theoretically)	Detection limit as digested proteins by ESI-MS
Conventional	4.6 mm	1 mL/min	1 x	
Semi-micro	2.1 mm	100 $\mu\text{L}/\text{min}$	5 x	
Micro	1.0 mm	10 $\mu\text{L}/\text{min}$	20 x	1 pmol
	300 μm	1 $\mu\text{L}/\text{min}$	230 x	100 fmol (equivalent to CBB staining)
Nano	75 μm	100 nL/min	3500 x	5 fmol (equivalent to silver staining)
	50 μm	100 nL/min	8000 x	
	10 μm	10 nL/min		50 amol (single cell analysis)

Figure 1: Relationship of HPLC scale with flow rate and sensitivity

In the nano-flow area, we can expect further sensitivity improvement by the reduction of background and minimization of sample loss in ESI spray. The estimated limit of detection for nano HPLC is about 5 fmol, which is at the same level as silver staining when an ESI interface with optimized performance is used with nano HPLC. Conversely, micro LC is on the same level (about 100 fmol) as that of CBB staining.

In order to perform reliable analysis in the nano flow area, stable reproducibility of retention time and noise reduction are key issues, and precise flow control is required to obtain stable nano-flow. Furthermore it is essential to reduce dead volume in the sample flow-path of nano HPLC since even small excess volumes cause peak broadening. Therefore, there is great demand for a stable front-end HPLC that can support such low-level flow rates.

The Prominence nano is a nano-flow LC system consisting of Prominence Series units, including a flow line switching valve for nano-level flow control and a solvent delivery unit that demonstrates excellent flow rate accuracy even at nano-level flows. In addition, the Nano-Assist control software offers intuitive operation of the Prominence nano system via a graphical user interface.

Reflux Flow Control

Syringe pumps or split-flow systems have been widely used for nano-flow analysis. However, syringe pumps require a long time to reach the set flow rate and the total cycle of analysis depends on syringe volume. In split-flow systems, the viscosity of mobile phases and flow resistance in the splitter is variable during gradient analysis. Variation of thermal conductivity during a gradient run also affects the flow sensor's output. These effects cause split-flow systems to provide unstable flow rates. Additionally, split-flow systems divert most of the mobile phase to waste.

To solve those problems, the Reflux Flow Control (RFC) system was adopted into the nano-flow pump, LC-20ADnano, to assure precise nano flow (Figure 2). In the LC-20ADnano, most of the mobile phase coming to the reflux block is rerouted to the inlet of the pump through the reflux path. The speed of the pump is controlled by signal feedback from the high-precision nano-flow sensor, which utilizes precise temperature control to minimize the

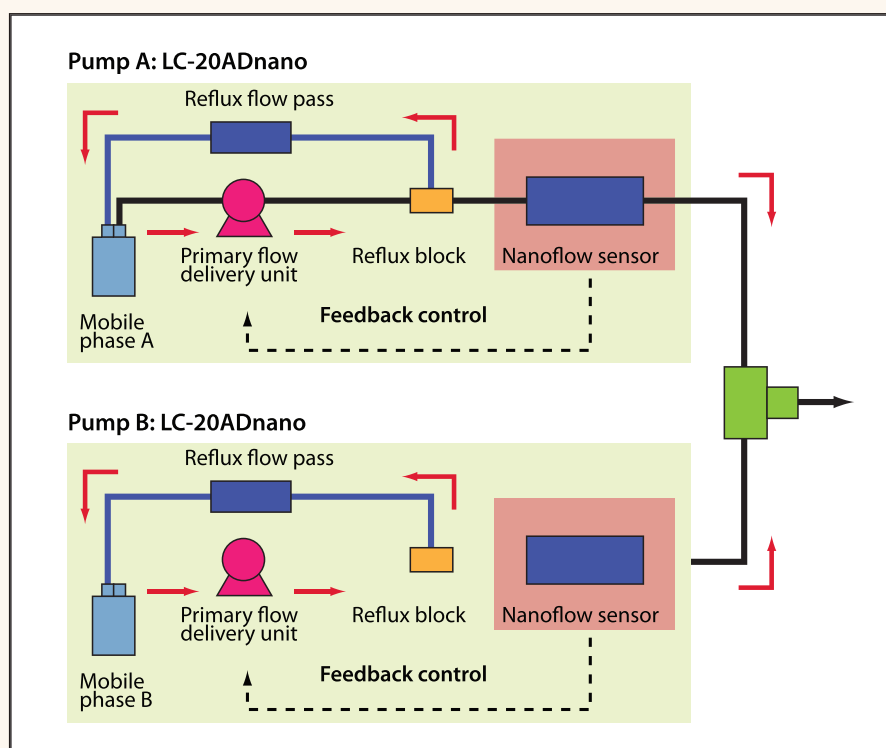

Figure 2: Reflux Flow Control (RFC) system

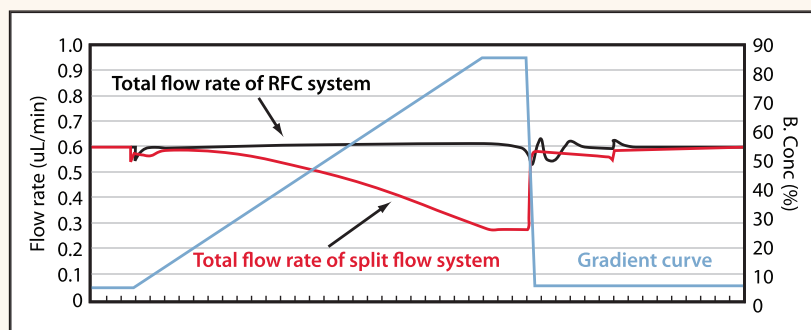

Figure 3: Observed total flow rate in gradient flow at 600nL/min

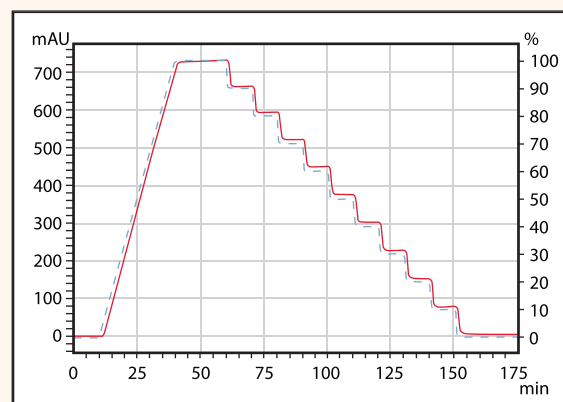

Figure 4: Gradient accuracy; broken line: gradient program (theoretical value); red solid line: observed value

influence of room temperature variation on actual flow rate. The flow sensor is not influenced by a variation of the physical property of mobile phases during gradient elution since the LC-2010ADnano utilizes the RFC system for each pump independently. Furthermore, the RFC system provides low solvent consumption because split mobile phases are re-used via the reflux flow pass.

Comparison of observed flow rate on the RFC system with that on a split system is shown in Figure 3. In both tests, the total flow setting was held at 600nL/min during gradient analysis by water/acetonitrile. In the split system, the actual flow rate decreased to half of the set value with the increase of acetonitrile content. On the other hand, the RFC system provided a stable flow rate in 5-85% of acetonitrile concentration.

Figure 4 shows a gradient profile at 600nL/min for flow rate by using water (:A) / acetone in water (:B) as mobile phases. The observed baseline drifted upward in proportion to the increase of acetone concentration because acetone has a strong UV absorbance. We can know the actual gradient accuracy by determining the proportional relationship of baseline absorbance with B concentration in the mobile phase. The actual gradient profile agreed well with the set step-gradient program as shown in Figure 4. Measured B concentration was 61.37% against 60% for the set value.

Excellent Retention Time Reproducibility

Proteome analysis requires separation and identification of many digested peptides with very similar retention characteristics. Consequently, reproducibility of retention time is very critical for peak comparison between different samples. The reproducibility of retention time for gradient conditions by the binary LC-20ADnano pumps was evaluated using digested BSA samples. The binary pumps demonstrated 0.2% RSD or less reproducibility (n=6) at a 300nL/min flow (Figure 5).

FCV nano – Switching Valve for Nano Flow

In a nano-flow HPLC, a trapping injection method is often used because this method can minimize the injected sample diffusion in the sample flow path. Furthermore, the method has the advantages of being able to load several uL or more of a sample and remove salts, which are often contained in bio-samples. A two-dimensional configuration is widely used for the separation of complex samples. An ion-exchange column and a reverse-phase column is a typical example of a combination of separation modes that are used for two-dimensional analysis.

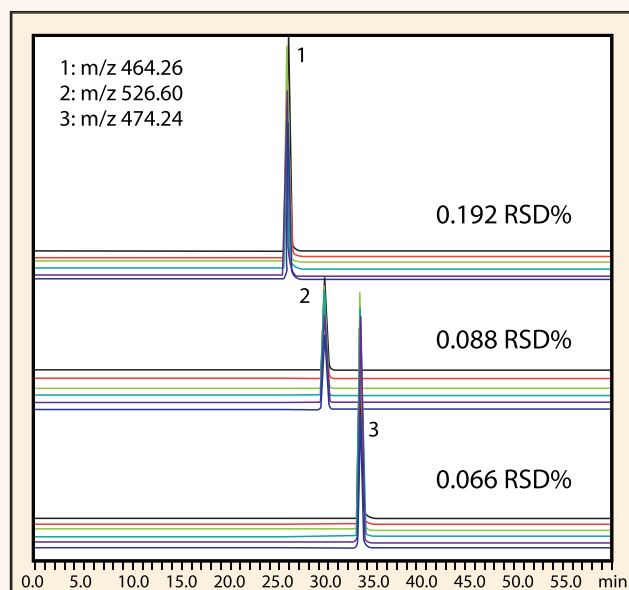

Figure 5: Reproducibility for a digested BSA sample (Retention time reproducibility of major peaks)

Chromatographic conditions

Column: PicoFrit (100 mmL.x75µmL.D.)

Mobile phase:

A) Water / Acetonitrile / Formic acid = 98/2/0.1 (v/v)

B) Water / Acetonitrile / Formic acid = 5/95/0.1 (v/v)

Gradient elution

Flow rate: 300nL/min

Temperature: Ambient temperature

Trapping column: L-column Micro (5 mmLx300µmL.D.)

Detection: LCMS-IT-TOF

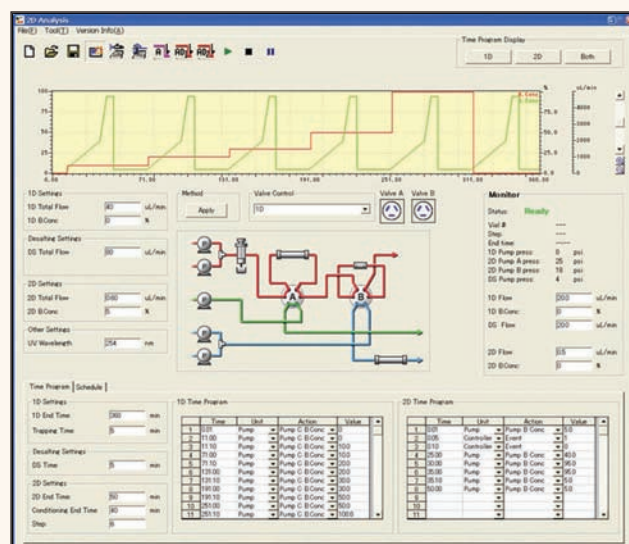

Figure 6: 2D LC setting window in Nano-Assist

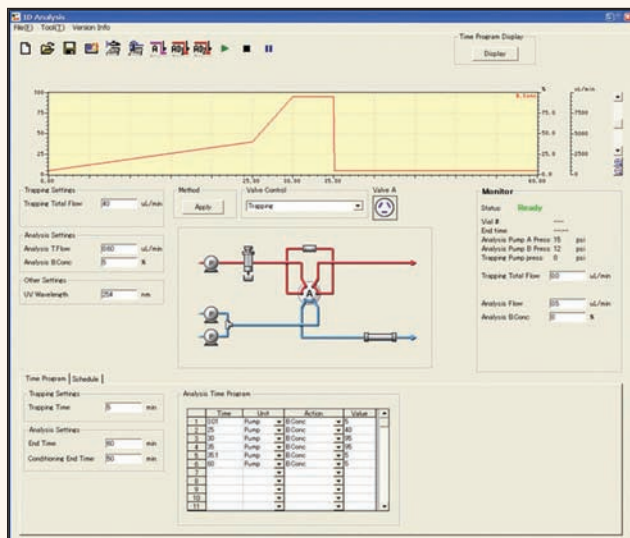

Figure 7: 1D LC setting window in Nano-Assist

To support those configurations, we have developed a nano valve which has a 2-position change and 6 connection ports. Sample diffusion and delay time in the valve is minimized since the volume between each 2 ports is only 25 nL. The combination of a surface-hardened stator and a PEEK rotor allows low adsorption and high durability to be achieved. Wear particles derived from repetitive rotation of the valve, which may cause clogging in nano-flow paths, are minimized.

Nano-Assist Control Software – Graphically Assisted Software Operation

Complicated gradient programming for two-dimensional HPLC is made easy by the Nano-Assist graphical user interface (Figure 6). Gradient programming for the 1st dimension and 2nd dimension can be input separately, and time programming for valve control can be easily created by inputting trapping time, desalting time and conditioning time. Visual presentations of flow-line connections and gradient curves help prevent operation errors. The Nano-Assist software can be used for both one-dimensional and two-dimensional configurations (Figure 7).

Higher Peak Capacity by Two-dimensional LC

Two-dimensional separations using a combination of different separation modes are used for analysis of complex samples, such as enzyme-digested protein mixtures, because two-dimensional separation provides a large peak capacity and can powerfully separate complex samples. Prominence nano is the most appropriate system to configure a two-dimensional HPLC for proteome analysis due to the reliable nano flow, excellent reproducibility of retention time, minimized dead volume valve design, and other benefits the Prominence HPLC can provide.

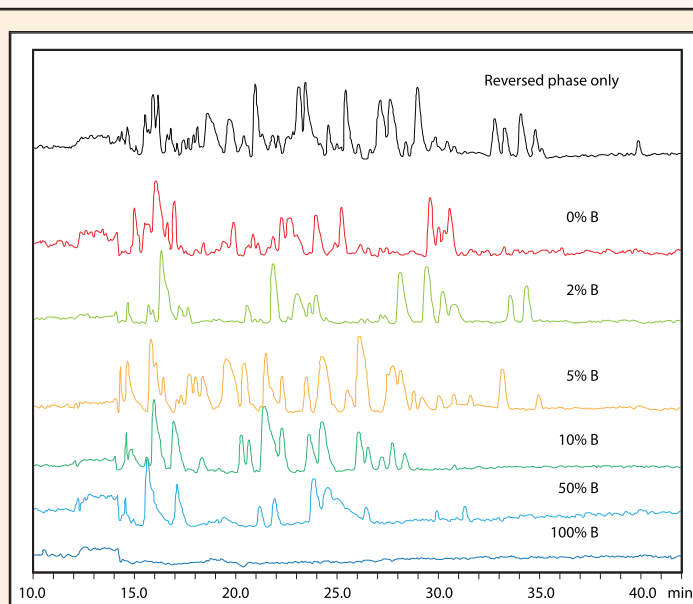

Figure 8: Separation of digested yeast proteins by 2-dimensional

LC Chromatographic conditions

[1st dimension]

Column: Polysulfoethyl A (50 mmL.×1 mmI.D.)

Mobile phase: Ammonium formate buffer

Salt step gradient

Flow rate: 40µL/min

Trapping column: L-column Micro (5 mmL.×300µmI.D.)

Trapping period: 5 minutes

Desalting solvent: Water / Formic acid = 100 / 0.1

Flow rate for desalting: 40µL/min

Desalting period: 5 minutes

[2nd dimension]

Column: PicoFrit (100 mmL.×75µmI.D.)

Mobile phase:

A) Water / Acetonitrile / Formic acid = 95/5/0.1 (v/v)

B) Water / Acetonitrile / Formic acid = 5/95/0.1 (v/v)

Gradient elution

Flow rate: 600 nL/min

Temperature: Ambient temperature

Detection: LCMS-IT-TOF

Sample: Digested Yeast proteins mixture (200 fmol as proteins)

A two-dimensional separation was performed for tryptic digested yeast proteins with Prominence nano-LCMS-IT-TOF (Figure 8). The digested proteins were separated by using ion-exchange chromatography for the 1st dimension and reversed-phase chromatography for the 2nd dimension. The upper trace is a chromatogram obtained by a one-dimensional HPLC using a reverse-phase column, and the six other traces are chromatograms obtained by a two-dimensional configuration. The nano LC with a two-dimensional configuration could separate many more peptide peaks compared with one-dimensional separation by reversed-phase mode.

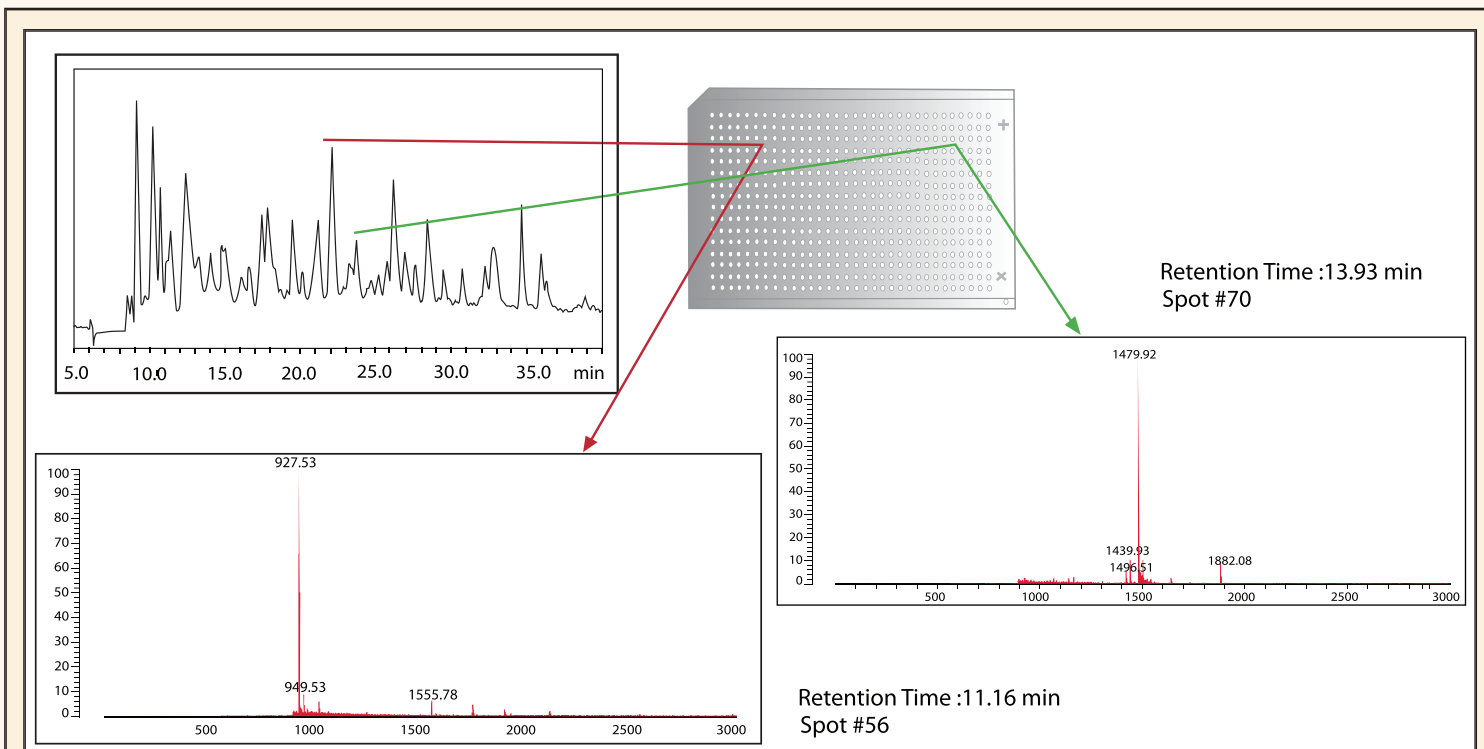

Figure 9: Analysis of a digested BSA sample (500 fmol as protein) by an off-line LC-MALDI

Chromatographic conditions

Detection: UV 220 nm

Column: MonoCap for Fast-flow (250 mmL.x100 μ mI.D.)

Mobile phase:

A) Water / Acetonitrile / TFA = 95/5/0.1 (v/v)

B) Water / Acetonitrile / TFA = 10/90/0.1 (v/v)

Gradient elution

Flow rate: 1 μ L/min

Temperature: Ambient temperature

Trapping column: ODS (1 mmLx0.5 mmI.D.)

Spotting period: Every 12 seconds

Spotting volume for one spot (200 nL except matrix solution)

MALDI-TOF MS System

The Prominence nano system also can be used with a MALDI TOF mass spectrometer using a MALDI plate spotting device. Digested BSA proteins were spotted on a MALDI plate by the Shimadzu MALDI plate spotting device, AccuSpot, connected to the 1D Prominence nano, and determined by a MALDI-TOF MS, AXIMA-CFR plus (Figure 9).

Several hundred nL/min flow rates are commonly applied for the spotting process on a MALDI plate. The Prominence nano is an HPLC ideally suited to offline LC-MALDI methodology since the Prominence nano provides the accurate nano flow that is required for spotting on MALDI plates.

Conclusion

With nano-flow LC, flow rates may only reach as high as 1 μ L/min. Because of this, the combination of nano flow LC with mass spectrometers is expected to become more widespread in the fields of biotechnology, medicinal chemistry, pharmaceuticals, etc. To fully realize its potential, though, a nano LC system must address reproducibility concerns, in addition to other basic performance features. With its reflux flow control system, specially designed nano valve, and easy-to-use GUI, the Prominence nano provides advanced flow-rate precision in the nano flow-rate range, making it a total solution for proteomic analyses. 



Online help: anytime, anywhere

The **LC Virtual Advisor** includes a maintenance section that provides animated, easy-to-follow maintenance procedures.

NOW AVAILABLE – LCMS Virtual Advisor

We are pleased to announce the new LCMS Virtual Advisor. Use your existing LC Virtual Advisor user name and password for access. You can also find the same content on the LC Virtual Advisor by creating a system with the LCMS-2010EV as a detector. The following LCMS content is available:

- LCMS Theory
- LCMS-2010EV Maintenance
- LCMS Basic Troubleshooting

More additions and updates will be added.

Visit http://www.ssi.shimadzu.com/LCMS_VirtualAdvisor to learn more.

Interactive LC Virtual Advisor

The web-based, interactive **LC Virtual Advisor** offers 24-hour interactive support for the Prominence HPLC Series. With 24-hour, password-protected access, users can custom-configure virtual systems to match their current or dream HPLC system configurations. The user can then access animated easy-to-follow maintenance procedures specific for their configured Prominence system. Users can also access the Troubleshooting section, which leads them to problem-solving procedures. A newer Advanced Troubleshooting module allows users to diagnose and correct many of the problems encountered with HPLC applications, using a step-by-step logical sequence of questions designed to troubleshoot chromatography issues.

The LC Virtual Advisor offers added convenience and learning opportunity, as the web site includes a reference/education section with a glossary of HPLC-related terms, and an ever-increasing list of other reference applications.

To learn more and to register, please visit www.shimadzu.com/lc_virtualadvisor

Founded in 1875, Shimadzu Corporation, a leader in the development of advanced technologies, has a distinguished history of innovation built on the foundation of contributing to society through science and technology. We maintain a global network of sales, service, technical support and applications centers on six continents, and have established long-term relationships with a host of highly trained distributors located in over 100 countries. For information about Shimadzu, and to contact your local office, please visit our Web site at www.shimadzu.com



SHIMADZU CORPORATION. International Marketing Division
3, Kanda-Nishikicho 1-chome, Chiyoda-ku, Tokyo 101-8448, Japan
Phone: 81(3)3219-5641 Fax: 81(3)3219-5710
URL <http://www.shimadzu.com>

The contents of this brochure are subject to change without notice.

Printed in Japan 3295-10803-50ANS