

**DICOM Conformance Statement  
for OPESCOPE ACTENO  
(SDR-120 Rev01.00.xx)**



NO TEXT

## Overview:

This conformance statement details the compliance to DICOM 3.0 of Digital Radiography SDR-120 mounted in the OPESCOPE ACTENO system.

Table below provides an overview of the network services supported by the SDR-120.

### NETWORK SERVICES

SOP Classes	User of Services (SCU)	Provider of Services (SCP)
<b>Transfer</b>		
X-Ray Radiofluoroscopic Image Storage	Yes	No
X-Ray Angiographic Image Storage	Yes	No
X-Ray Radiation Dose SR Storage	Yes	No
<b>Workflow Management</b>		
Modality Worklist Information Model – FIND	Yes	No
Modality Performed Procedure Step	Yes	No
<b>Print Management</b>		
Basic Grayscale Print Management Meta	Yes	No
Basic Film Session	Yes	No
Basic Film Box	Yes	No
Basic Grayscale Image Box	Yes	No
Printer	Yes	No
Print Job	Yes	No

Table below provides an overview of the Media Storage Application Profiles supported by the SDR-120.

### MEDIA SERVICES

Media Storage Application Profile	Write Files (FSC or FSU)	Read Files (FSR)
<b>DVD</b>		
General Purpose CD-R	Yes	No

## TABLE OF CONTENTS:

<b>1. INTRODUCTION.....</b>	<b>5</b>
1.1. REVISION HISTORY .....	5
1.2. AUDIENCE .....	5
1.3. REMARKS .....	5
1.4. TERMS AND DEFINITIONS .....	6
1.5. BASICS OF DICOM COMMUNICATION .....	8
1.6. ABBREVIATIONS .....	9
1.7. REFERENCES.....	9
<b>2. NETWORKING .....</b>	<b>10</b>
2.1. IMPLEMENTATION MODEL.....	10
2.1.1. Application Data Flow .....	10
2.1.2. Functional Definitions of AE's .....	12
2.1.3. Sequencing of Real-World Activities.....	13
2.2. AE SPECIFICATIONS .....	15
2.2.1. Storage Application Entity Specification .....	15
2.2.2. Workflow Application Entity Specification.....	21
2.2.3. Hardcopy Application Entity Specification .....	36
2.3. NETWORK INTERFACES .....	47
2.3.1. Physical Network Interface .....	47
2.3.2. IPv4 and IPv6 Support .....	47
2.4. CONFIGURATION.....	48
2.4.1. AE Title/Presentation Address Mapping.....	48
2.4.2. Parameters.....	49
<b>3. MEDIA INTERCHANGE.....</b>	<b>50</b>
3.1. IMPLEMENTATION MODEL.....	50
3.1.1. Application Data Flow .....	50
3.1.2. Functional Definition of AE's .....	50
3.1.3. Sequencing of Real-World Activities.....	50
3.1.4. File Meta Information Options .....	50
3.2. AE SPECIFICATIONS .....	51
3.2.1. Offline-Media Application Entity Specification.....	51
3.3. AUGMENTED AND PRIVATE APPLICATION PROFILES .....	52
3.4. MEDIA CONFIGURATION .....	52
<b>4. SUPPORT OF CHARACTER SETS .....</b>	<b>53</b>
<b>5. SECURITY .....</b>	<b>53</b>
<b>6. ANNEXES.....</b>	<b>54</b>
6.1. IOD CONTENTS .....	54
6.1.1. Created SOP Instances.....	54
6.1.2. Used Fields in received IOD by application .....	82
6.1.3. Attribute mapping .....	82
6.1.4. Coerced/Modified Fields.....	83
6.2. DATA DICTIONARY OF PRIVATE ATTRIBUTES .....	84
6.3. CODED TERMINOLOGY AND TEMPLATES .....	84
6.4. GRAYSCALE IMAGE CONSISTENCY .....	84
6.5. STANDARD EXTENDED/SPECIALIZED/PRIVATE SOP CLASSES.....	84
6.6. PRIVATE TRANSFER SYNTAXES .....	84

# 1. INTRODUCTION

## 1.1. REVISION HISTORY

Revision	Date	Description
First Edition	2014/01	New Release

## 1.2. AUDIENCE

This document is written for the people that need to understand how the SDR-120 will integrate into their healthcare facility. This includes both those responsible for overall imaging network policy and architecture, as well as integrators who need to have a detailed understanding of the DICOM features of the product.

This document contains some basic DICOM definitions so that any reader may understand how this product implements DICOM features. However, integrators are expected to fully understand all the DICOM terminology, how the tables in this document relate to the product's functionality, and how that functionality integrates with other devices that support compatible DICOM features.

## 1.3. REMARKS

The scope of this DICOM Conformance Statement is to facilitate integration between the SDR-120 and other DICOM products. The Conformance Statement should be read and understood in conjunction with the DICOM Standard. DICOM by itself does not guarantee interoperability. The Conformance Statement does, however, facilitate a first-level comparison for interoperability between different applications supporting compatible DICOM functionality.

This Conformance Statement is not supposed to replace validation with other DICOM equipment to ensure proper exchange of intended information. In fact, the user should be aware of the following important issues:

- The comparison of different Conformance Statements is just the first step towards assessing interconnectivity and interoperability between the product and other DICOM conformant equipment.
- Test procedures should be defined and executed to validate the required level of interoperability with specific compatible DICOM equipment, as established by the healthcare facility.

## 1.4. TERMS AND DEFINITIONS

Informal definitions are provided for the following terms used in this Conformance Statement. The DICOM Standard is the authoritative source for formal definitions of these terms.

**Abstract Syntax** – the information agreed to be exchanged between applications, generally equivalent to a Service/Object Pair (SOP) Class.

Examples : Verification SOP Class, Modality Worklist Information Model Find SOP Class, Computed Radiography Image Storage SOP Class.

**Application Entity (AE)** – an end point of a DICOM information exchange, including the DICOM network or media interface software; i.e., the software that sends or receives DICOM information objects or messages. A single device may have multiple Application Entities.

**Application Entity Title** – the externally known name of an Application Entity, used to identify a DICOM application to other DICOM applications on the network.

**Application Context** – the specification of the type of communication used between Application Entities. Example: DICOM network protocol.

**Association** – a network communication channel set up between Application Entities.

**Attribute** – a unit of information in an object definition; a data element identified by a tag. The information may be a complex data structure (Sequence), itself composed of lower level data elements. Examples: Patient ID (0010,0020), Accession Number (0008,0050), Photometric Interpretation (0028,0004), Procedure Code Sequence (0008,1032).

**Information Object Definition (IOD)** – the specified set of Attributes that comprise a type of data object; does not represent a specific instance of the data object, but rather a class of similar data objects that have the same properties. The Attributes may be specified as Mandatory (Type 1), Required but possibly unknown (Type 2), or Optional (Type 3), and there may be conditions associated with the use of an Attribute (Types 1C and 2C).

Examples: MR Image IOD, CT Image IOD, Print Job IOD.

**Module** – a set of Attributes within an Information Object Definition that are logically related to each other.

Example: Patient Module includes Patient Name, Patient ID, Patient Birth Date, and Patient Sex.

**Negotiation** – first phase of Association establishment that allows Application Entities to agree on the types of data to be exchanged and how that data will be encoded.

**Presentation Context** – the set of DICOM network services used over an Association, as negotiated between Application Entities; includes Abstract Syntaxes and Transfer Syntaxes.

**Protocol Data Unit (PDU)** – a packet (piece) of a DICOM message sent across the network. Devices must specify the maximum size packet they can receive for DICOM messages.

**Service Class Provider (SCP)** – role of an Application Entity that provides a DICOM network service; typically, a server that performs operations requested by another Application Entity (Service Class User). Examples: Picture Archiving and Communication System (image storage SCP, and image query/retrieve SCP), Radiology Information System (modality worklist SCP).

**Service Class User (SCU)** – role of an Application Entity that uses a DICOM network service; typically, a client.

Examples: imaging modality (image storage SCU, and modality worklist SCU), imaging workstation (image query/retrieve SCU)

**Service/Object Pair (SOP) Class** – the specification of the network or media transfer (service) of a particular type of data (object); the fundamental unit of DICOM interoperability specification. Examples: Ultrasound Image Storage Service, Basic Grayscale Print Management.

**Service/Object Pair (SOP) Instance** – an information object; a specific occurrence of information exchanged in a SOP Class.

Examples: a specific x-ray image.

**Tag** – a 32-bit identifier for a data element, represented as a pair of four digit hexadecimal numbers, the “group” and the “element”. If the “group” number is odd, the tag is for a private (manufacturer-specific) data element.

Examples: (0010,0020) [Patient ID], (07FE,0010) [Pixel Data], (0019,0210) [private data element]

**Transfer Syntax** – the encoding used for exchange of DICOM information objects and messages.

Examples: JPEG compressed (images), little endian explicit value representation.

**Unique Identifier (UID)** – a globally unique “dotted decimal” string that identifies a specific object or a class of objects; an ISO-8824 Object Identifier.

Examples: Study Instance UID, SOP Class UID, SOP Instance UID.

**Value Representation (VR)** – the format type of an individual DICOM data element, such as text, an integer, a person’s name, or a code. DICOM information objects can be transmitted with either explicit identification of the type of each data element (Explicit VR), or without explicit identification (Implicit VR); with Implicit VR, the receiving application must use a DICOM data dictionary to look up the format of each data element.

## 1.5. BASICS OF DICOM COMMUNICATION

This section describes terminology used in this Conformance Statement for the non-specialist. The key terms used in the Conformance Statement are highlighted in *italics* below. This section is not a substitute for training about DICOM, and it makes many simplifications about the meanings of DICOM terms.

Two *Application Entities* (devices) that want to communicate with each other over a network using DICOM protocol must first agree on several things during an initial network “handshake”. One of the two devices must initiate an *Association* (a connection to the other device), and ask if specific services, information, and encoding can be supported by the other device (*Negotiation*).

DICOM specifies a number of network services and types of information objects, each of which is called an *Abstract Syntax* for the Negotiation. DICOM also specifies a variety of methods for encoding data, denoted *Transfer Syntaxes*. The Negotiation allows the initiating Application Entity to propose combinations of Abstract Syntax and Transfer Syntax to be used on the Association; these combinations are called *Presentation Contexts*. The receiving Application Entity accepts the Presentation Contexts it supports.

For each Presentation Context, the Association Negotiation also allows the devices to agree on *Roles* – which one is the *Service Class User* (SCU - client) and which is the *Service Class Provider* (SCP - server). Normally the device initiating the connection is the SCU, i.e., the client system calls the server, but not always.

The Association Negotiation finally enables exchange of maximum network packet (*PDU*) size, security information, and network service options (called *Extended Negotiation* information).

The Application Entities, having negotiated the Association parameters, may now commence exchanging data. Common data exchanges include queries for worklists and lists of stored images, transfer of image objects and analyses (structured reports), and sending images to film printers. Each exchangeable unit of data is formatted by the sender in accordance with the appropriate *Information Object Definition*, and sent using the negotiated Transfer Syntax. There is a Default Transfer Syntax that all systems must accept, but it may not be the most efficient for some use cases. Each transfer is explicitly acknowledged by the receiver with a *Response Status* indicating success, failure, or that query or retrieve operations are still in process.

Two Application Entities may also communicate with each other by exchanging media (such as a DVD-R). Since there is no Association Negotiation possible, they both use a *Media Application Profile* that specifies “pre-negotiated” exchange media format, Abstract Syntax, and Transfer Syntax.



## 1.6. ABBREVIATIONS

AE	Application Entity
AET	Application Entity Title
CR	Computed Radiography
CT	Computed Tomography
DHCP	Dynamic Host Configuration Protocol
DICOM	Digital Imaging and Communications in Medicine
DNS	Domain Name System
DX	Digital X-ray
GSDf	Grayscale Standard Display Function
GSPS	Grayscale Softcopy Presentation State
HIS	Hospital Information System
IHE	Integrating the Healthcare Enterprise
IOD	Information Object Definition
IPv4	Internet Protocol version 4
ISO	International Organization for Standardization
LDAP	Lightweight Directory Access Protocol
LUT	Look-up Table
MPPS	Modality Performed Procedure Step
MSPS	Modality Scheduled Procedure Step
MWL	Modality Worklist
NTP	Network Time Protocol
PACS	Picture Archiving and Communication System
PDU	Protocol Data Unit
RF	Radiofluoroscopy
RIS	Radiology Information System
SCP	Service Class Provider
SCU	Service Class User
SOP	Service-Object Pair
SPS	Scheduled Procedure Step
TCP/IP	Transmission Control Protocol/Internet Protocol
UL	Upper Layer
VM	Value Multiplicity
VR	Value Representation

## 1.7. REFERENCES

- NEMA PS3      Digital Imaging and Communications in Medicine (DICOM) Standard, available free at <http://dicom.nema.org/>

## 2. NETWORKING

### 2.1. IMPLEMENTATION MODEL

#### 2.1.1. Application Data Flow

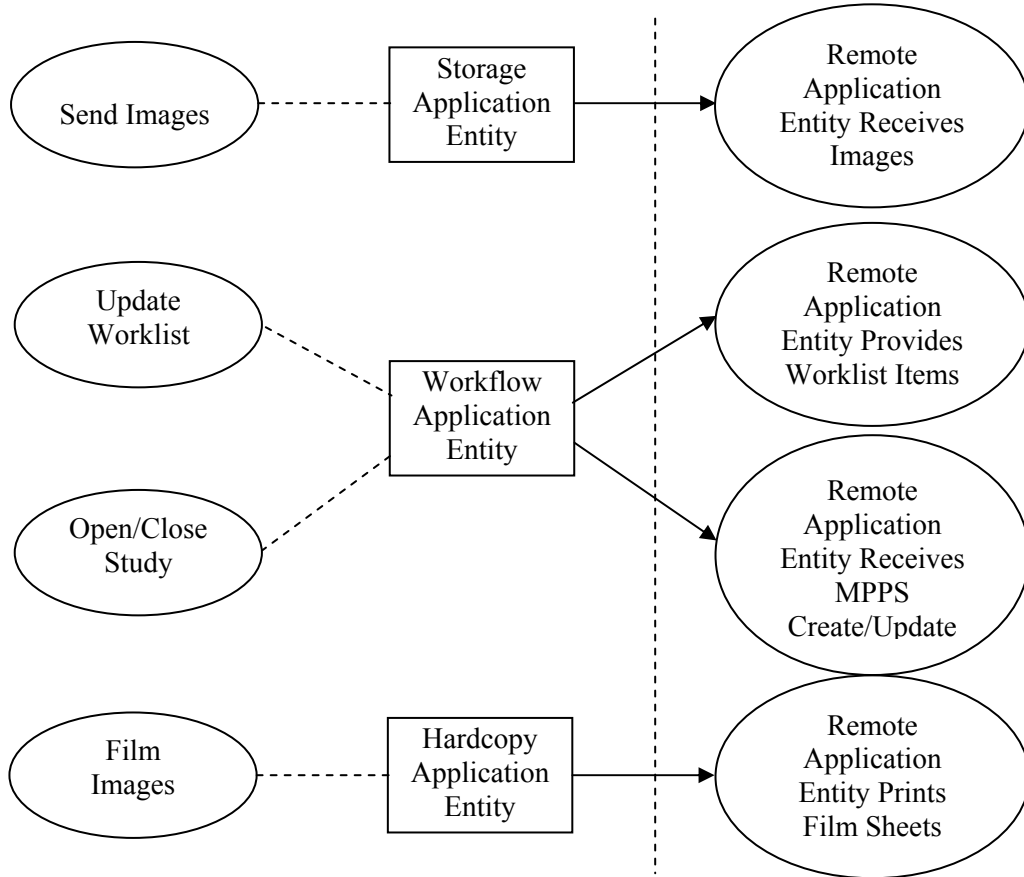

**Figure 2.1-1**  
**APPLICATION DATA FLOW DIAGRAM**

The Storage Application Entity sends images to a remote AE. It is associated with the local real-world activity “Send Images”. “Send Images” is performed upon user request for each radiography/study or for specific images selected. When activated by user’s settings (auto-send), each marked set of images can be immediately stored to a preferred destination whenever next radiography is performed or a Patient/Study is closed by the user.

The Workflow Application Entity receives Worklist information from and sends MPPS information to a remote AE. It is associated with the local real-world activities “Update Worklist” and “Open/Close Study”. When the “Update Worklist” local real-world activity is performed the Workflow Application Entity queries a remote AE for worklist items and provides the set of worklist items matching the query request. “Update Worklist” is performed as a result of an operator request or can be performed automatically at specific operation. When the “Open/Close Study” local real-world activity is performed the Worklist Application Entity creates and updates Modality Performed Procedure Step instances managed by a remote AE. Opening Study will result in automated creation of an MPPS Instance. Completion of the MPPS is performed as the result of an operator action.

The Hardcopy Application Entity prints images on a remote AE (Printer). It is associated with the real-world activity “Film Images”. “Film Images” creates a print-job within the print queue containing one or more virtual film sheets composed from images selected by the user.

## **2.1.2. Functional Definitions of AE's**

### **2.1.2.1. Functional Definition of Storage Application Entity**

The existence of a send-job queue entry with associated network destination will activate the Storage AE. An association request is sent to the destination AE and upon successful negotiation of a Presentation Context the image transfer is started. If the association cannot be opened, the related send-job is set to an error state and can be restarted by the user via job control interface. By default, the Storage AE will not try to initiate another association for this send-job automatically.

### **2.1.2.2. Functional Definition of Workflow Application Entity**

Worklist Update attempts to download a Worklist from a remote node. If the Workflow AE establishes an Association to a remote AE, it will transfer all worklist items via the open Association. During receiving the worklist response items are counted and the query processing is canceled if the configurable limit of items is reached. The result will be displayed in a separate list, which can be cleared with the next Worklist Update based on the configuration.

The Workflow AE performs the creation of a MPPS Instance automatically whenever studies are started. Further updates on the MPPS data can be performed interactively from the related MPPS user interface. The MPPS "Complete" or "Discontinued" states can only be set from the user interface.

### **2.1.2.3. Functional Definition of Hardcopy Application Entity**

The existence of a print-job in the print queue will activate the Hardcopy AE. An association is established with the printer and the printer's status determined. If the printer is operating normally, the film sheets described within the print-job will be printed. Changes in printer status will be detected (e.g. out of film) and reported to the user. If the printer is not operating normally, the print-job will set to an error state and can be restarted by the user via the job control interface.

### 2.1.3. Sequencing of Real-World Activities

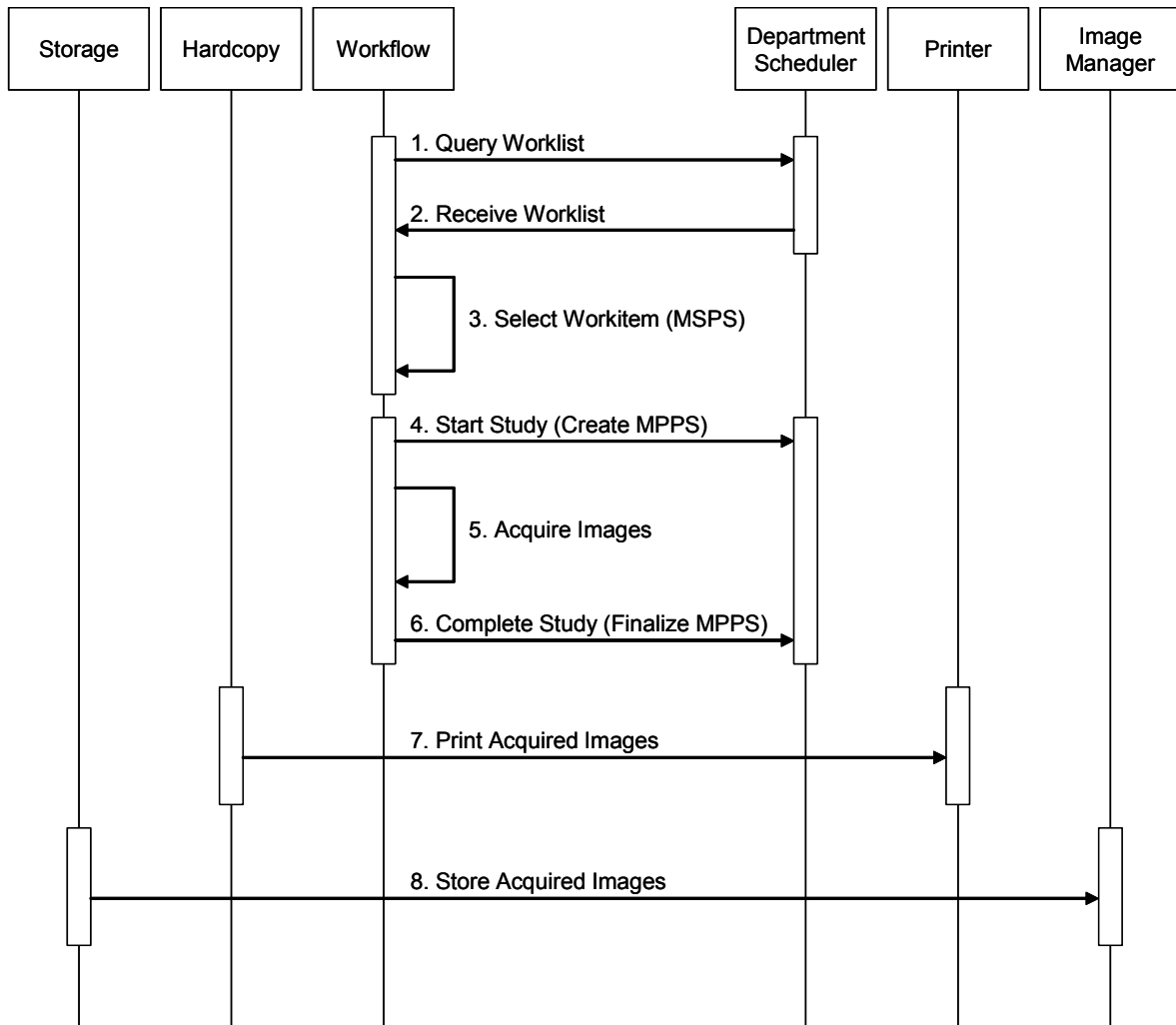

**Figure 2.1-2 SEQUENCING CONSTRAINTS**

Under normal scheduled workflow conditions the sequencing constraints illustrated in Figure 2-1-2 apply;

1. Query Worklist
2. Receive Worklist of Modality Scheduled Procedure Steps (MSPS)
3. Select Workitem (MSPS) from Worklist
4. Start Study and create MPPS
5. Acquire Images
6. Complete Study and finalize MPPS
7. Print acquired images (optional step)
8. Store acquired images

Other workflow situations (e.g. unscheduled procedure steps) will have other sequencing constraints.

Printing could equally take place after the acquired images have been stored. Printing could be omitted completely if no printer is connected or hardcopies are not required.

## 2.2. AE SPECIFICATIONS

### 2.2.1. Storage Application Entity Specification

#### 2.2.1.1. SOP Classes

The SDR-120 provides Standard Conformance to the following SOP Classes:

**Table 2.2-1**  
**SOP CLASSES FOR AE STORAGE**

SOP Class Name	SOP Class UID	SCU	SCP
X-Ray Radiofluoroscopic Image Storage	1.2.840.10008.5.1.4.1.1.12.2	Yes	No
X-Ray Angiographic Image Storage	1.2.840.10008.5.1.4.1.1.12.1	Yes	No
XR Radiation Dose SR Storage	1.2.840.10008.5.1.4.1.1.88.67	Yes	No

#### 2.2.1.2. Association Policies

##### 2.2.1.2.1. General

The DICOM standard application context name for DICOM 3.0 is always proposed:

**Table 2.2-2**  
**DICOM APPLICATION CONTEXT FOR AE STORAGE**

Application Context Name	1.2.840.10008.3.1.1.1
--------------------------	-----------------------

##### 2.2.1.2.2. Number of Associations

The SDR-120 initiates one Association at a time for each destination to which a transfer request is being processed in the active job queue list. Only one job will be active at a time, the other remains pending until the active job is completed or failed.

**Table 2.2-3**  
**NUMBER OF ASSOCIATIONS INITIATED FOR AE STORAGE**

Maximum number of simultaneous Associations	1
---	---

**2.2.1.2.3. Asynchronous Nature**

The SDR-120 does not support asynchronous communication (multiple outstanding transactions over a single Association).

**Table 2.2-4**

**ASYNCHRONOUS NATURE AS A SCU FOR AE STORAGE**

Maximum number of outstanding asynchronous transactions	1
---	---

**2.2.1.2.4. Implementation Identifying Information**

The implementation information for this Application Entity is:

**Table 2.2-5**

**DICOM IMPLEMENTATION CLASS AND VERSION FOR AE STORAGE**

Implementation Class UID	1.2.392.200036.9110.1.0.6711.2001002
Implementation Version Name	SPF XX (XX : version number)

**2.2.1.3. Association Initiation Policy**

**2.2.1.3.1. Activity – Send Images**

**2.2.1.3.1.1. Description and Sequencing of Activities**

A user can select images and request them to be sent to multiple destinations. Each request is forwarded to the job queue and processed individually. When the “Auto-send” option is active, each marked instance or marked set of instances stored in database will be forwarded to the network job queue for a pre-configured auto-send target destination. It can be configured which instances will be automatically marked and the destination where the instances are automatically sent to. The “Auto-send” is triggered by the next acquisition.

The Storage AE is invoked by the job control interface that is responsible for processing network archival tasks. The job consists of data describing the instances marked for storage and the destination. An internal daemon process triggered by a job for a specific network destination initiates a C-STORE request to store images. If the process successfully establishes an Association to a remote Application Entity, it will transfer each marked instance one after another via the open Association. Status of the transfer is reported through the job control interface. Only one job will be active at a time. If the C-STORE Response from the remote Application contains a status other than Success or Warning, the Association is aborted and the related Job is switched to a failed state. It can be restarted any time by user interaction.

The Storage AE attempts to initiate a new Association in order to issue a C-STORE request. If the job contains multiple images then multiple C-STORE requests will be issued over the same Association.



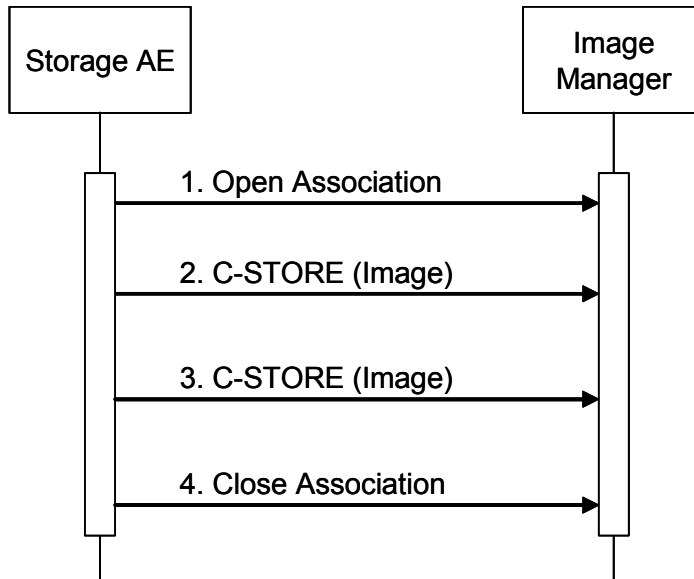

**Figure 2.2-1 SEQUENCE OF ACTIVITY – SEND IMAGES**

A possible sequence of interactions between the Storage AE and an Image Manager (e.g. a storage or archive device supporting the Storage SOP Class as an SCP) is illustrated in Figure above:

1. The Storage AE opens an association with the Image Manager
2. An acquired image is transmitted to the Image Manager using a C-STORE request and the Image Manager replies with a C-STORE response (status success).
3. Another acquired image is transmitted to the Image Manager using a C-STORE request and the Image Manager replies with a C-STORE response (status success).
4. The Storage AE closes the association with the Image Manager.

NOTE: Many other message sequences are possible depending on the number of images to be stored.

**2.2.1.3.1.2. Proposed Presentation Contexts**

The SDR-120 is capable of proposing the Presentation Contexts shown in the following table:

**Table 2.2-6**

**PROPOSED PRESENTATION CONTEXTS FOR ACTIVITY SEND IMAGES**

<b>Presentation Context Table</b>					
<b>Abstract Syntax</b>		<b>Transfer Syntax</b>		<b>Role</b>	<b>Ext. Neg.</b>
<b>Name</b>	<b>UID</b>	<b>Name</b>	<b>UID</b>		
X-Ray Radio Fluoroscopic Image Storage	1.2.840.10008.5.1.4.1.1.12.2	Implicit VR Little Endian	1.2.840.10008.1.2	SCU	None
		Explicit VR Little Endian	1.2.840.10008.1.2.1		
		Explicit VR Big Endian	1.2.840.10008.1.2.2		
X-Ray Angiographic Image Storage	1.2.840.10008.5.1.4.1.1.12.1	Implicit VR Little Endian	1.2.840.10008.1.2	SCU	None
		Explicit VR Little Endian	1.2.840.10008.1.2.1		
		Explicit VR Big Endian	1.2.840.10008.1.2.2		
X-Ray Radiation Dose SR Storage	1.2.840.10008.5.1.4.1.1.88.67	Implicit VR Little Endian	1.2.840.10008.1.2	SCU	None
		Explicit VR Little Endian	1.2.840.10008.1.2.1		
		Explicit VR Big Endian	1.2.840.10008.1.2.2		

Presentation Contexts for each Image Storage will only be proposed if the Send Job contains instances for these SOP Classes.

### 2.2.1.3.1.3. SOP Specific Conformance Image Storage SOP Classes

All Image Storage SOP Classes supported by the Storage AE exhibit the same behaviour, except where stated, and are described together in this section.

**Table 2.2-7**

#### **STORAGE C-STORE RESPONSE STATUS HANDLING BEHAVIOR**

<b>Service Status</b>	<b>Further Meaning</b>	<b>Error Code</b>	<b>Behavior</b>
Success	Success	0000	The SCP has successfully stored the SOP Instance. If all SOP Instances in a send job have status success then the job is marked as complete.
Refused	Out of Resources	A700- A7FF	The Association is released using A-RELEASE and the send job is marked as failed. The status meaning is logged and the job failure is reported to the user via the job control application. This is a transient failure.
Error	Data Set does not match SOP Class	A900- A9FF	The Association is released using A-RELEASE and the send job is marked as failed. The status meaning is logged and the job failure is reported to the user via the job control application.
Error	Cannot Understand	C000- CFFF	The Association is released using A-RELEASE and the send job is marked as failed. The status meaning is logged and the job failure is reported to the user via the job control application.
Warning	Coercion of Data Elements	B000	Image transmission is considered successful but the status meaning is logged.
Warning	Elements Discarded	B006	Image transmission is considered successful but the status meaning is logged.
Warning	Data Set does not match SOP Class	B007	Image transmission is considered successful. The status meaning is logged and the job warning is reported to the user via the job control application.
*	*	Any other status code.	The Association is released using A-RELEASE and the send job is marked as failed. The status code is logged and the job failure is reported to the user via the job control application.

The behaviour of Storage AE during communication failure is summarized in the Table below:

**Table 2.2-8**  
**STORAGE COMMUNICATION FAILURE BEHAVIOR**

<b>Exception</b>	<b>Behavior</b>
Timeout	The Association is released using A-RELEASE and the send job is marked as failed. The reason is logged and the job failure is reported to the user via the job control application.
Association aborted by the SCP or network layers	The send job is marked as failed The reason is logged and the job failure is reported to the user via the job control application.

A failed send job can be restarted by user interaction.

The contents of each Image Storage SOP Instances created by the SDR-120 conform to the DICOM Image IOD definition and are described in Annex A of this document.

## 2.2.2. Workflow Application Entity Specification

### 2.2.2.1. SOP Classes

The SDR-120 provides Standard Conformance to the following SOP Classes:

**Table 2.2-9**

#### SOP CLASSES SUPPORTED FOR AE WORKFLOW

SOP Class Name	SOP Class UID	SCU	SCP
Modality Worklist Information Model - FIND	1.2.840.10008.5.1.4.31	Yes	No
Modality Performed Procedure Step	1.2.840.10008.3.1.2.3.3	Yes	No

### 2.2.2.2. Association Policies

#### 2.2.2.2.1. General

The DICOM standard application context name for DICOM 3.0 is always proposed:

**Table 2.2-10**

#### DICOM APPLICATION CONTEXT FOR AE WORKFLOW

Application Context Name	1.2.840.10008.3.1.1.1
--------------------------	-----------------------

#### 2.2.2.2.2. Number of Associations

The SDR-120 initiates one Association at a time for Worklist request.

**Table 2.2-11**

#### NUMBER OF ASSOCIATIONS INITIATED FOR AE WORKFLOW

Maximum number of simultaneous Associations	1
---	---

#### 2.2.2.2.3. Asynchronous Nature

The SDR-120 does not support asynchronous communication (multiple outstanding transactions over a single Association).

**Table 2.2-12**

#### ASYNCHRONOUS NATURE AS A SCU FOR AE WORKFLOW

Maximum number of outstanding asynchronous transactions	1
---	---

#### 2.2.2.2.4. Implementation Identifying Information

The implementation information for this Application Entity is:

**Table 2.2-13**

#### **DICOM IMPLEMENTATION CLASS AND VERSION FOR AE WORKFLOW**

Implementation Class UID	1.2.392.200036.9110.1.0.6711.2001002
Implementation Version Name	SPF XX (XX : version number)

### 2.2.2.3. Association Initiation Policy

#### 2.2.2.3.1. Activity – Worklist Update

##### 2.2.2.3.1.1. Description and Sequencing of Activities

The request for a Worklist Update is initiated by user interaction, i.e. pressing the buttons “Update” / ”Query” or automatically triggered by specific operation. With “Update” the automated query mechanism is performed immediately on request, while with “Query” a dialog to enter search criteria is opened an interactive query can be performed.

The interactive Patient Worklist Query will display a dialog for entering data as search criteria. When the Query is started on user request, only the data from the dialog will be inserted as matching keys into the query.

Upon initiation of the request, the SDR-120 will build an Identifier for the C-FIND request, will initiate an Association to send the request and will wait for Worklist responses. After retrieval of all responses, the SDR-120 will access the local database to add or update patient demographic data. To protect the system from overflow, the SDR-120 will limit the number of processed worklist responses to a configurable maximum. During receiving the worklist response items are counted and the query processing is canceled by issuing a C-FIND-CANCEL if the configurable limit of items is reached.

The SDR-120 will initiate an Association in order to issue a C-FIND request according to the Modality Worklist Information Model.

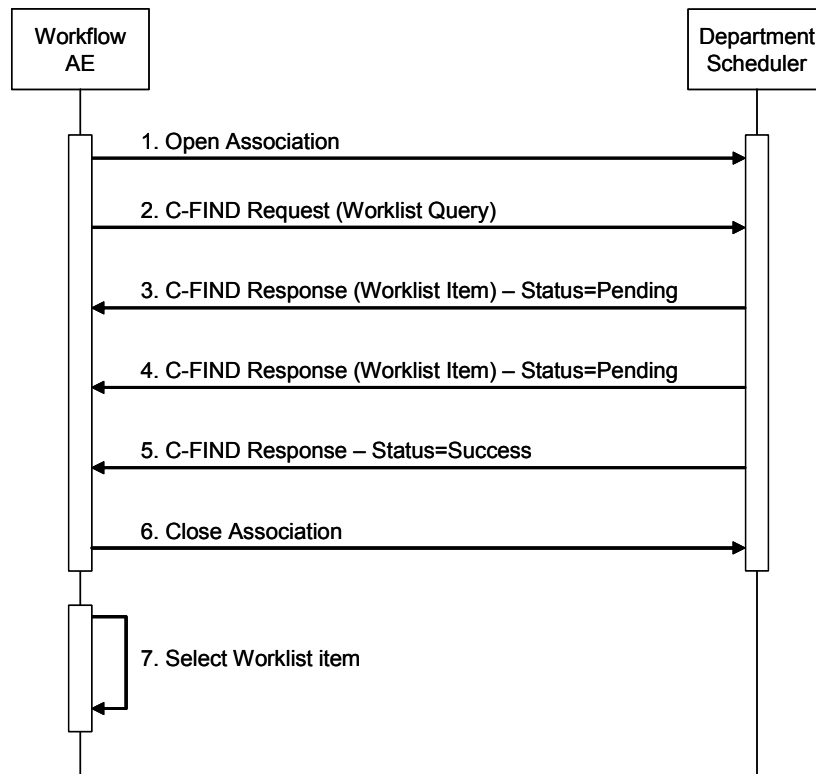

**Figure 2.2-2 SEQUENCE OF ACTIVITY – WORKLIST UPDATE**

A possible sequence of interactions between the Workflow AE and a Department Scheduler (e.g. a device such as a RIS or HIS which supports the Modality Worklist SOP Class as an SCP) is illustrated in Figure above:

1. The Worklist AE opens an association with the Department Scheduler.
2. The Worklist AE sends a C-FIND request to the Department Scheduler containing the Worklist Query attributes.
3. The Department Scheduler returns a C-FIND response containing the requested attributes of the first matching Worklist Item.
4. The Department Scheduler returns another C-FIND response containing the requested attributes of the second matching Worklist Item.
5. The Department Scheduler returns another C-FIND response with status Success indicating that no further matching Worklist Items exist. This example assumes that only 2 Worklist items match the Worklist Query.
6. The Worklist AE closes the association with the Department Scheduler.
7. The user selects a Worklist Item from the Worklist and prepares to acquire new images.

**2.2.2.3.1.2. Proposed Presentation Contexts**

The SDR-120 will propose Presentation Contexts as shown in the following table:

**Table 2.2-14**

**PROPOSED PRESENTATION CONTEXTS FOR WORKLIST UPDATE**

<b>Presentation Context Table</b>					
<b>Abstract Syntax</b>		<b>Transfer Syntax</b>		<b>Role</b>	<b>Ext. Neg.</b>
<b>Name</b>	<b>UID</b>	<b>Name</b>	<b>UID</b>		
Modality Worklist Information Model – FIND	1.2.840.10008.5.1.4.31	Implicit VR Little Endian	1.2.840.10008.1.2	SCU	None
		Explicit VR Little Endian	1.2.840.10008.1.2.1		
		Explicit VR Big Endian	1.2.840.10008.1.2.2		

**2.2.2.3.1.3. SOP Specific Conformance for Modality Worklist**

The behavior of the SDR-120 when encountering status codes in a Modality Worklist C-FIND response is summarized in the Table below. If any other SCP response status than “Success” or “Pending” is received by the SDR-120, an error message will appear on the user interface.

**Table 2.2-15**

**MODALITY WORKLIST C-FIND RESPONSE STATUS HANDLING BEHAVIOR**

<b>Service Status</b>	<b>Further Meaning</b>	<b>Error Code</b>	<b>Behavior</b>
Success	Matching is complete	0000	The SCP has completed the matches. Worklist items are available for display or further processing.
Refused	Out of Resources	A700	The Association is released using A-RELEASE and the worklist query is marked as failed. The status meaning is logged and reported to the user if an interactive query. Any additional error information in the Response will be logged.
Failed	Identifier does not match SOP Class	A900	The Association is released using A-RELEASE and the worklist query is marked as failed. The status meaning is logged and reported to the user if an interactive query. Any additional error information in the Response will be logged.
Failed	Unable to Process	C000-CFFF	The Association is released using A-RELEASE and the worklist query is marked as failed. The status meaning is logged and reported to the user if an interactive query. Any additional error information in the Response will be logged.
Cancel	Matching terminated due to Cancel request	FE00	If the query was cancelled due to too many worklist items then the SCP has completed the matches. Worklist items are available for display or further processing. Otherwise, the Association is released using A-RELEASE and the worklist query is marked as failed. The status meaning is logged and reported to the user if an interactive query.



<b>Service Status</b>	<b>Further Meaning</b>	<b>Error Code</b>	<b>Behavior</b>
Pending	Matches are continuing	FF00	The worklist item contained in the Identifier is collected for later display or further processing.
Pending	Matches are continuing – Warning that one or more Optional Keys were not supported	FF01	The worklist item contained in the Identifier is collected for later display or further processing. The status meaning is logged only once for each C-FIND operation.
*	*	Any other status code.	The Association is released using A-RELEASE and the worklist is marked as failed. The status meaning is logged and reported to the user if an interactive query. Any additional error information in the Response will be logged.

The behaviour of the SDR-120 during communication failure is summarized in the Table below.

**Table 2.2-16**

**MODALITY WORKLIST COMMUNICATION FAILURE BEHAVIOR**

<b>Exception</b>	<b>Behavior</b>
Timeout	The Association is released using A-RELEASE and the worklist query is marked as failed. The reason is logged and reported to the user if an interactive query.
Association aborted by the SCP or network layers	The worklist query is marked as failed The reason is logged and reported to the user if an interactive query.

Acquired images will always use the Study Instance UID specified for the Scheduled Procedure Step (if available). If an acquisition is unscheduled, a Study Instance UID will be generated locally.

The Table below provides a description of the SDR-120 Worklist Request Identifier and specifies the attributes that are copied into the images. Unexpected attributes returned in a C-FIND response are ignored.

Requested return attributes not supported by the SCP are set to have no value. Non-matching responses returned by the SCP due to unsupported optional matching keys are ignored.

**Table 2.2-17  
WORKLIST REQUEST IDENTIFIER**

Module Name Attribute Name	Tag	VR	M	R	Q	D	IOD
SOP Common							
Specific Character Set	(0008,0005)	CS	S				
Scheduled Procedure Step							
Scheduled Procedure Step Sequence	(0040,0100)	SQ		x			
> Modality	(0008,0060)	CS	S		x		
> Requested Contrast Agent	(0032,1070)	LO					
> Scheduled Station AE Title	(0040,0001)	AE	S	x	x		
> Scheduled Procedure Step Start Date	(0040,0002)	DA	R		x	x	
> Scheduled Procedure Step Start Time	(0040,0003)	TM	R		x	x	
> Scheduled Performing Physician's Name	(0040,0006)	PN		x			
> Scheduled Procedure Step Description	(0040,0007)	LO		x			
> Scheduled Protocol Code Sequence	(0040,0008)	SQ		x			
> Code Value	(0008,0100)	CS		x			
> Coding Scheme Designator	(0008,0102)	SH		x			
> Coding Scheme Version	(0008,0103)	SH		x			
> Code Meaning	(0008,0104)	LO		x			
> Scheduled Procedure Step ID	(0040,0009)	SH		x			
> Scheduled Station Name	(0040,0010)	SH		x			
Requested Procedure							
Referenced Study Sequence	(0008,1110)	SQ		x			
> Referenced SOP Class UID	(0008,1150)	UI		x			
> Referenced SOP Instance UID	(0008,1155)	UI		x			
Study Instance UID	(0020,000D)	UI		x			
Requested Procedure Description	(0032,1060)	LO		x			
Requested Procedure Code Sequence	(0032,1064)	SQ		x			
> Code Value	(0008,0100)	CS		x			
> Coding Scheme Designator	(0008,0102)	SH		x			
> Coding Scheme Version	(0008,0103)	SH		x			
> Code Meaning	(0008,0104)	LO		x			

Module Name Attribute Name	Tag	VR	M	R	Q	D	IOD
Requested Procedure ID	(0040,1001)	SH		x	x		
Imaging Service Request							
Accession Number	(0008,0050)	SH	S	x	x	x	
Referring Physician's Name	(0008,0090)	PN		x			
Requesting Physician	(0032,1032)	PN		x			
Patient Identification							
Patient Name	(0010,0010)	PN	S*	x	x	x	
Patient ID	(0010,0020)	LO	S*	x	x	x	
Patient Demographic							
Patient's Birth Date	(0010,0030)	DA		x		x	
Patient's Sex	(0010,0040)	CS		x		x	
Patient's Age	(0010,1010)	AS				x	
Patient's Size	(0010,1020)	DS		x		x	
Patient's Weight	(0010,1030)	DS		x		x	
Patient Medical							
Medical Alerts	(0010,2000)	LO		x		x	
Special Needs	(0038,0050)	LO		x		x	

The above table should be read as follows:

Module Name: The name of the associated module for supported worklist attributes.

Attribute Name: Attributes supported to build an SDR-120 Worklist Request Identifier.

Tag: DICOM tag for this attribute.

VR: DICOM VR for this attribute.

M: Matching keys for Worklist Update. A "S" will indicate that the SDR-120 will supply an attribute value for Single Value Matching, a "R" will indicate Range Matching and a "\*" will denote wildcard matching.

R: Return keys. An "x" will indicate that the SDR-120 will supply this attribute as Return Key with zero length for Universal Matching.

Q: Interactive Query Key. An "x" will indicate that the SDR-120 will supply this attribute as matching key, if entered in the Query Patient Worklist dialog. For example, the Patient Name can be entered thereby restricting Worklist responses to Procedure Steps scheduled for the patient.

D: Displayed keys. An "x" indicates that this worklist attribute is displayed to the user during a patient registration dialog. For example, Patient Name will be displayed when registering the patient prior to an examination.

IOD: An “x” indicates that this Worklist attribute is included into all Object Instances created during performance of the related Procedure Step.

### **2.2.2.3.2. Activity – Acquire Images**

#### **2.2.2.3.2.1. Description and Sequencing of Activities**

After Patient registration, the SDR-120 is awaiting starting study of the patient. The trigger to create a MPPS SOP Instance is derived from this event. An Association to the configured MPPS SCP system is established immediately and the related MPPS SOP Instance will be created.

The SDR-120 will set its status as “DISCONTINUED” when closing the study without any X-Ray exposure during the study. Otherwise, the status will be set as “COMPLETED”. A MPPS Instance that has been sent with a state of “COMPLETED” or “DISCONTINUED” can no longer be updated.

The SDR-120 will support creation of “unscheduled cases” by allowing MPPS Instances to be communicated for locally registered Patients.

The SDR-120 will initiate an Association to issue an:

- N-CREATE request according to the CREATE Modality Performed Procedure Step SOP Instance operation.
- N-SET request to update the contents and state of the MPPS according to the SET Modality Performed Procedure Step Information operation.

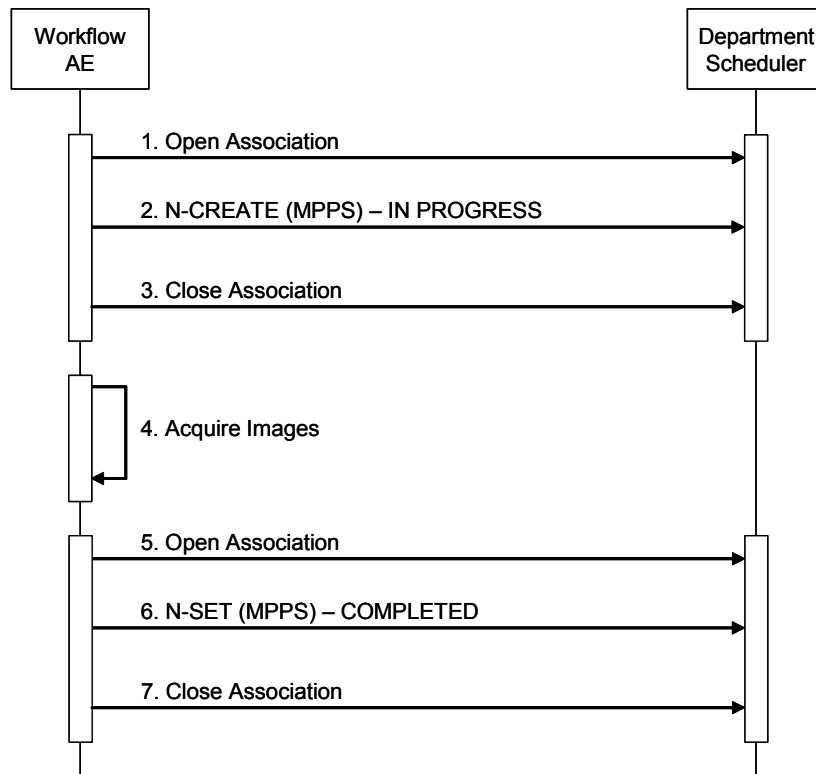

**Figure 2.2-3 SEQUENCE OF ACTIVITY – ACQUIRE IMAGES**

A possible sequence of interactions between the Workflow AE and a Department Scheduler (e.g. a device such as a RIS or HIS which supports the MPPS SOP Class as an SCP) is illustrated in Figure above:

1. The Worklist AE opens an association with the Department Scheduler.
2. The Worklist AE sends an N-CREATE request to the Department Scheduler to create an MPPS instance with status of “IN PROGRESS” and create all necessary attributes. The Department Scheduler acknowledges the MPPS creation with an N-CREATE response (status success).
3. The Worklist AE closes the association with the Department Scheduler.
4. All images are acquired and stored in the local database.
5. The Worklist AE opens an association with the Department Scheduler.
6. The Worklist AE sends an N-SET request to the Department Scheduler to update the MPPS instance with status of “COMPLETED” and set all necessary attributes. The Department Scheduler acknowledges the MPPS update an N-SET response (status success).
7. The Worklist AE closes the association with the Department Scheduler.

**2.2.2.3.2.2. Proposed Presentation Contexts**

The SDR-120 will propose Presentation Contexts as shown in the following table:

**Table 2.2-18**

**PROPOSED PRESENTATION CONTEXTS FOR REAL-WORLD ACTIVITY ACQUIRE IMAGES**

<b>Presentation Context Table</b>					
<b>Abstract Syntax</b>		<b>Transfer Syntax</b>		<b>Role</b>	<b>Ext. Neg.</b>
<b>Name</b>	<b>UID</b>	<b>Name</b>	<b>UID</b>		
Modality Performed Procedure Step	1.2.840.10008.3.1 .2.3.3	Implicit VR Little Endian	1.2.840.10008.1.2	SCU	None
		Explicit VR Little Endian	1.2.840.10008.1.2.1		
		Explicit VR Big Endian	1.2.840.10008.1.2.2		

**2.2.2.3.2.3. SOP Specific Conformance for MPPS**

The behavior of the SDR-120 when encountering status codes in an MPPS N-CREATE or N-SET response is summarized in the Table below. If any other SCP response status than “Success” or “Warning” is received by the SDR-120, an error message will appear on the user interface.

**Table 2.2-19**

**MPPS N-CREATE / N-SET RESPONSE STATUS HANDLING BEHAVIOR**

<b>Service Status</b>	<b>Further Meaning</b>	<b>Error Code</b>	<b>Behavior</b>
Success	Success	0000	The SCP has completed the operation successfully.
Failed	Processing Failure – Performed Procedure Step Object may no longer be updated	0110	The Association is released using A-RELEASE and the MPPS is marked as failed. The status meaning is logged and reported to the user. Additional information in the Response will be logged.
Warning	Attribute Value Out of Range	0116	The MPPS operation is considered successful but the status meaning is logged. Additional information in the Response identifying the attributes out of range will be logged.
*	*	Any other status code.	The Association is released using A-RELEASE and the MPPS is marked as failed. The status meaning is logged and reported to the user.

The behaviour of the SDR-120 during communication failure is summarized in the Table below.

**Table 2.2-20  
MODALITY WORKLIST COMMUNICATION FAILURE BEHAVIOR**

Exception	Behavior
Timeout	The Association is released using A-RELEASE and the MPPS is marked as failed. The reason is logged and reported to the user.
Association aborted by the SCP or network layers	The MPPS is marked as failed The reason is logged and reported to the user.

The following Table provides a description of the MPPS N-CREATE and N-SET request identifiers sent by the SDR-120. Empty cells in the N-CREATE and N-SET columns indicate that the attribute is not sent. An “x” indicates that an appropriate value will be sent. A “Zero length” attribute will be sent with zero length.

**Table 2.2-21  
MPPS N-CREATE / N-SET REQUEST IDENTIFIER**

Attribute Name	Tag	VR	N-CREATE	N-SET
Specific Character Set	(0008,0005)	CS	In Japanese Mode: “\ISO 2022 IR 87\ISO 2022 IR 159” or “\ISO 2022 IR 87”  In English Mode: “ISO IR 100”	In Japanese Mode: “\ISO 2022 IR 87\ISO 2022 IR 159” or “\ISO 2022 IR 87”  In English Mode: “ISO IR 100”
Modality	(0008,0060)	CS	“RF/XA” Note: This is determined by the user.	
Procedure Code Sequence	(0008,1032)	SQ	From Modality Worklist	
> Code Value	(0008,0100)	SH	From Modality Worklist	
> Coding Scheme Designator	(0008,0102)	SH	From Modality Worklist	
> Coding Scheme Version	(0008,0103)	SH	From Modality Worklist	
> Code Meaning	(0008,0104)	LO	From Modality Worklist	
Referenced Patient Sequence	(0008,1120)	SQ	Zero length	
Patient’s Name	(0010,0010)	PN	From Modality Worklist or user input (3 component groups with 5 components)	

<b>Attribute Name</b>	<b>Tag</b>	<b>VR</b>	<b>N-CREATE</b>	<b>N-SET</b>
Patient ID	(0010,0020)	LO	From Modality Worklist or user input	
Patient's Birth Date	(0010,0030)	DA	From Modality Worklist or user input	
Patient's Sex	(0010,0040)	CS	From Modality Worklist or user input	
Distance Source to Detector (SID)	(0018,1110)	DS	From configuration	
Image and Fluoroscopy Area Dose Product	(0018,115E)	DS	Zero length	Total DAP
Study ID	(0020,0010)	SH	Auto input	
Performed Station AE Title	(0040,0241)	AE	MPPS AE Title from configuration	
Performed Station Name	(0040,0242)	SH	From configuration	
Performed Location	(0040,0243)	SH	From configuration	
Performed Procedure Step Start Date	(0040,0244)	DA	Actual start date	
Performed Procedure Step Start Time	(0040,0245)	TM	Actual start time	
Performed Procedure Step End Date	(0040,0250)	DA	Zero length	Actual end date
Performed Procedure Step End Time	(0040,0251)	TM	Zero length	Actual end time
Performed Procedure Step Status	(0040,0252)	CS	"IN PROGRESS"	"DISCONTINUED" or, "COMPLETED"
Performed Procedure Step ID	(0040,0253)	SH	From Modality Worklist or from configuration	
Performed Procedure Step Description	(0040,0254)	LO	From Modality Worklist	
Performed Procedure Type Description	(0040,0255)	LO	Zero length	
Performed Protocol Code Sequence	(0040,0260)	SQ	Zero length	Zero or more items
> Code Value	(0008,0100)	SH		From Modality Worklist
> Coding Scheme Designator	(0008,0102)	SH		From Modality Worklist



Attribute Name	Tag	VR	N-CREATE	N-SET
> Coding Scheme Version	(0008,0103)	SH		From Modality Worklist
> Code Meaning	(0008,0104)	LO		From Modality Worklist
Scheduled Step Attributes Sequence	(0040,0270)	SQ	If 1st dose applied results in an Instance	
> Accession Number	(0008,0050)	SH	From Modality Worklist or user input	
> Referenced Study Sequence	(0008,1110)	SQ	Zero length	
> Study Instance UID	(0020,000D)	UI	From Modality Worklist or generated by device	
> Requested Procedure Description	(0032,1060)	LO	From Modality Worklist	
> Scheduled Procedure Step Description	(0040,0007)	LO	From Modality Worklist	
> Scheduled Protocol Code Sequence	(0040,0008)	SQ	From Modality Worklist	
>> Code Value	(0008,0100)	SH	From Modality Worklist	
>> Coding Scheme Designator	(0008,0102)	SH	From Modality Worklist	
>> Coding Scheme Version	(0008,0103)	SH	From Modality Worklist	
>> Code Meaning	(0008,0104)	LO	From Modality Worklist	
> Scheduled Procedure Step ID	(0040,0009)	SH	From Modality Worklist	
> Requested Procedure ID	(0040,1001)	SH	From Modality Worklist	
Total Time of Fluoroscopy	(0040,0300)	US	Zero length	Total Time of Fluoroscopy
Total Number of Exposures	(0040,0301)	US	Zero length	Number of exposures. Number of Fluoroscopy is not included.
Entrance Dose	(0040,0302)	US		Total Entrance Dose (Air Kerma)
Distance Source to Entrance (SOD)	(0040,0306)	DS	Zero length	Actual SOD
Exposure Dose Sequence	(0040,030E)	SQ	Zero length	Contain Total Number of Exposure (0040, 0301) items plus an item for the last fluoroscopy episode in that study.
> KVP	(0018,0060)	DS		Actual KV
> Exposure Time	(0018,1150)	IS		Actual Exposure Time

Attribute Name	Tag	VR	N-CREATE	N-SET
> Radiation Mode	(0018,115A)	CS		Radiography : “PULSED” Fluoroscopy : “CONTINUOUS”
> X-Ray Tube Current in micro A	(0018,8151)	DS		Actual X-Ray Tube Current in micro A
> Filter Type	(0018,1160)	CS		Zero length
> Filter Material	(0018,7050)	CS		Zero length
>Exposure Time in uS	(0018,8150)	DS		Actual Exposure Time in uS
Film Consumption Sequence	(0040,0321)	SQ	Zero length	Zero or more items
> Film Size ID	(2010,0050)	CS		Actual Film Size being printed during the study
> Number of Films	(2100,0170)	IS		Actual Number of Films being printed during the study
Performed Series Sequence	(0040,0340)	SQ	Zero length	Only one item
> Retrieve AE Title	(0008,0054)	AE		Zero length
> Series Description	(0008,103E)	LO		Procedure Name and its Description selected when the study is closed
> Performing Physician’s Name	(0008,1050)	PN		Performing Physician’s Name
> Operator’s Name	(0008,1070)	PN		Operator’s Name
> Referenced Image Sequence	(0008,1140)	SQ		Zero of more items
>> Referenced SOP Class UID	(0008,1150)	UI		“1.2.840.10008.5.1.4.1.1.12.2” or “1.2.840.10008.5.1.4.1.1.12.1”
>> Referenced SOP Instance UID	(0008,1155)	UI		x
>> Protocol Name	(0018, 1030)	LO		Name and Description of the selected Protocol
> Series Instance UID	(0020,000E)	UI		x
> Referenced Non-Image Composite SOP Instance Sequence	(0040,0220)	SQ	Zero length	Zero or one Item
>> Referenced SOP Class UID	(0008,1150)	UI		“1.2.840.10008.5.1.4.1.1.88.67” In case of RDSR disable, this tag is not output.

Attribute Name	Tag	VR	N-CREATE	N-SET
>> Referenced SOP Instance UID	(0008,1155)	UI		“x” In case of RDSR disable, this tag is not output.
Entrance Dose in mGy	(0040,8302)	DS		Total Entrance Dose (Air Kerma) in mGy

#### 2.2.2.4. Association Acceptance Policy

The Workflow Application Entity does not accept Associations.

### 2.2.3. Hardcopy Application Entity Specification

#### 2.2.3.1. SOP Classes

The SDR-120 provides Standard Conformance to the following SOP Classes:

**Table 2.2-22**  
**SOP CLASSES FOR AE HARDCOPY**

SOP Class Name	SOP Class UID	SCU	SCP
Basic Grayscale Print Management Meta	1.2.840.10008.5.1.1.9	Yes	No
Basic Film Session	1.2.840.10008.5.1.1.1	Yes	No
Basic Film Box	1.2.840.10008.5.1.1.2	Yes	No
Basic Grayscale Image Box	1.2.840.10008.5.1.1.4	Yes	No
Printer	1.2.840.10008.5.1.1.16	Yes	No
Print Job	1.2.840.10008.5.1.1.14	Yes	No

#### 2.2.3.2. Association Policies

##### 2.2.3.2.1. General

The DICOM standard application context name for DICOM 3.0 is always proposed:

**Table 2.2-23**  
**DICOM APPLICATION CONTEXT FOR AE HARDCOPY**

Application Context Name	1.2.840.10008.3.1.1.1
--------------------------	-----------------------

##### 2.2.3.2.2. Number of Associations

The SDR-120 initiates one Association at a time for each configured hardcopy device. Multiple hardcopy devices can be configured.

**Table 2.2-24**  
**NUMBER OF ASSOCIATIONS INITIATED FOR AE HARDCOPY**

Maximum number of simultaneous Associations	1
---	---

#### 2.2.3.2.3. Asynchronous Nature

The SDR-120 does not support asynchronous communication (multiple outstanding transactions over a single Association).

**Table 2.2-25**

#### **ASYNCHRONOUS NATURE AS A SCU FOR AE HARDCOPY**

Maximum number of outstanding asynchronous transactions	1
---	---

#### 2.2.3.2.4. Implementation Identifying Information

The implementation information for this Application Entity is:

**Table 2.2-26**

#### **DICOM IMPLEMENTATION CLASS AND VERSION FOR AE HARDCOPY**

Implementation Class UID	1.2.392.200036.9110.1.0.6711.2001002
Implementation Version Name	SPF XX (XX : version number)

### 2.2.3.3. Association Initiation Policy

#### 2.2.3.3.1. Activity – Film Images

##### 2.2.3.3.1.1. Description and Sequencing of Activities

A user can compose images onto film sheets and requests them to be sent to a specific hardcopy device. The user can select the desired film format and number of copies. Each print-job is forwarded to the job queue and processed individually.

The Hardcopy AE is invoked by the job control interface that is responsible for processing network tasks. The job consists of data describing the images and graphics to be printed as well as the requested layout and other parameters. Each images on the sheet is sent to the specified device and will be set in the same sheet there. If no association to the printer can be established, the print-job is switched to a failed state and the user informed.

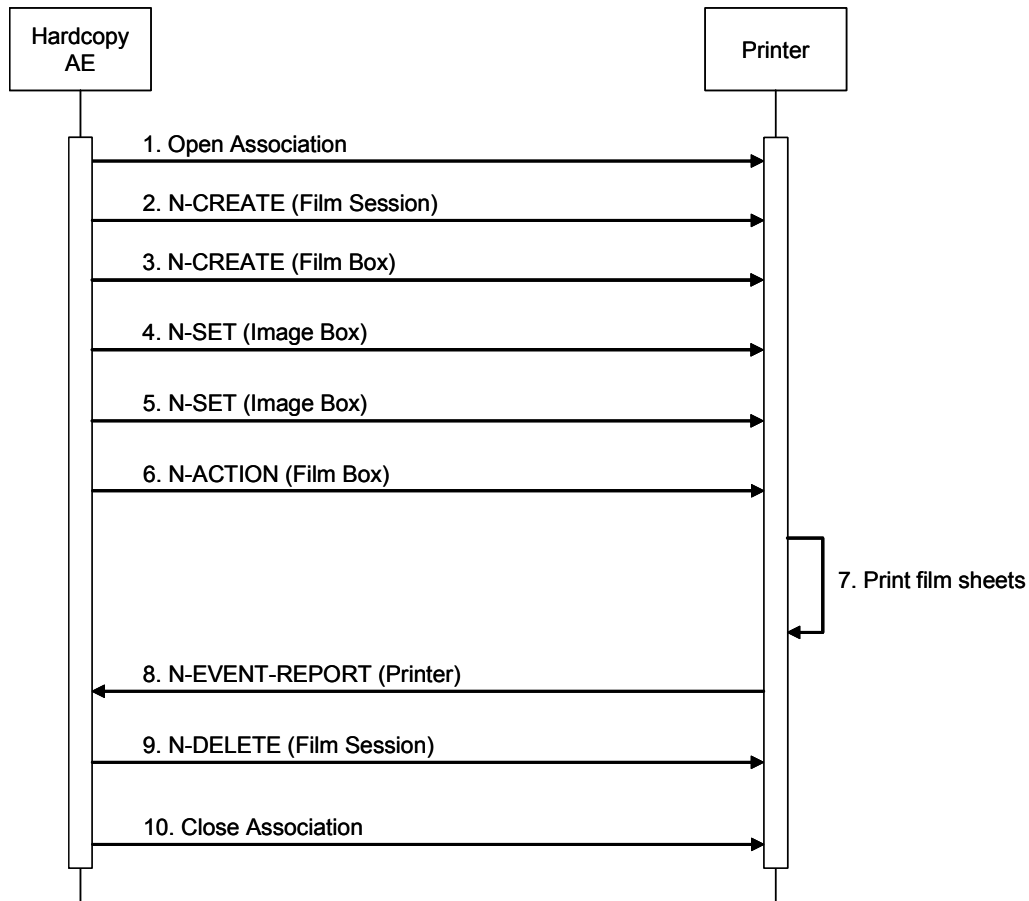

**Figure 2.2-4 SEQUENCE OF ACTIVITY – FILM IMAGES**

A typical sequence of DIMSE messages sent over an association between Hardcopy AE and a Printer is illustrated in Figure above:

1. Hardcopy AE opens an association with the Printer
2. N-CREATE on the Film Session SOP Class creates a Film Session.
3. N-CREATE on the Film Box SOP Class creates a Film Box linked to the Film Session.
4. N-SET on the Image Box SOP Class transfers image of the film sheet to the printer.
5. N-SET on the Image Box SOP Class transfers another image of the film sheet to the printer.
6. N-ACTION on the Film Box SOP Class instructs the printer to print the Film Box.
7. The printer prints the requested number of film sheets.
8. The Printer asynchronously reports its status via N-EVENT-REPORT notification (Printer SOP Class). The printer can send this message at any time. Hardcopy AE does not require the N-EVENT-REPORT to be sent. Hardcopy AE is capable of receiving an N-EVENT-REPORT notification at any time during an association. If the Printer reports a status of FAILURE, the print-job is switched to a failed status and the user informed.

- 9. N-DELETE on the Film Session SOP Class deletes the complete Film Session SOP Instance hierarchy.
- 10. Hardcopy AE closes the association with the Printer.

Status of the print-job is reported through the job control interface. Only one job will be active at a time for each separate hardcopy device. If any Response from the remote Application contains a status other than Success or Warning, the Association is aborted and the related job is switched to a failed state. It can be restarted any time by user interaction.

**2.2.3.3.1.2. Proposed Presentation Contexts**

The SDR-120 is capable of proposing the Presentation Contexts shown in the following table:

**Table 2.2-27**

**PROPOSED PRESENTATION CONTEXTS FOR ACTIVITY FILM IMAGES**

<b>Presentation Context Table</b>					
<b>Abstract Syntax</b>		<b>Transfer Syntax</b>		<b>Role</b>	<b>Ext. Neg.</b>
<b>Name</b>	<b>UID</b>	<b>Name</b>	<b>UID</b>		
Basic Grayscale Print Management (META)	1.2.840.10008.5.1 .1.9	Implicit VR Little Endian	1.2.840.10008.1.2	SCU	None
		Explicit VR Little Endian	1.2.840.10008.1.2.1		
		Explicit VR Big Endian	1.2.840.10008.1.2.2		
Print Job	1.2.840.10008.5.1 .1.14	Implicit VR Little Endian	1.2.840.10008.1.2	SCU	None
		Explicit VR Little Endian	1.2.840.10008.1.2.1		
		Explicit VR Big Endian	1.2.840.10008.1.2.2		

**2.2.3.3.1.3. Common SOP Specific Conformance for all Print SOP Classes**

The general behavior of Hardcopy AE during communication failure is summarized in the Table below. This behavior is common for all SOP Classes supported by Hardcopy AE.

**Table 2.2-28  
HARDCOPY COMMUNICATION FAILURE BEHAVIOR**

<b>Exception</b>	<b>Behavior</b>
Timeout	The Association is released using A-RELEASE and the print-job is marked as failed. The reason is logged and the job failure is reported to the user via the job control application.
Association aborted by the SCP or network layers	The print-job is marked as failed. The reason is logged and the job failure is reported to the user via the job control application.

**2.2.3.3.1.4. SOP Specific Conformance for the Printer SOP Class**

Hardcopy AE supports the following DIMSE notifications for the Printer SOP Class:

- N-EVENT-REPORT

Details of the supported attributes and status handling behaviour are described in the following subsections.

**2.2.3.3.1.4.1. Printer SOP Class Operation (N-EVENT-REPORT)**

Hardcopy AE is capable of receiving an N-EVENT-REPORT request at any time during an association.

The behavior of Hardcopy AE when receiving Event Types within the N-EVENT-REPORT is summarized in the Table below:

**Table 2.2-29  
PRINTER SOP CLASS N-EVENT-REPORT BEHAVIOUR**

<b>Event Type Name</b>	<b>Event Type ID</b>	<b>Behaviour</b>
Normal	1	The print-job continues to be printed.
Warning	2	The print-job continues to be printed. The contents of Printer Status Info (2110,0020) is logged and reported to the user via the job-control application.
Failure	3	The print-job is marked as failed. The contents of Printer Status Info (2110,0020) is logged and reported to the user via the job-control application.
*	*	An invalid Event Type ID will cause a status code of 0113H to be returned in a N-EVENT-REPORT response.



The reasons for returning specific status codes in a N-EVENT-REPORT response are summarized in the Table below:

**Table 2.2-30  
PRINTER SOP CLASS N-EVENT-REPORT RESPONSE STATUS REASONS**

<b>Service Status</b>	<b>Further Meaning</b>	<b>Error Code</b>	<b>Reasons</b>
Success	Success	0000	The notification event has been successfully received.
Failure	No Such Event Type	0113	An invalid Event Type ID was supplied in the N-EVENT-REPORT request.
Failure	Processing Failure	0110	An internal error occurred during processing of the N-EVENT-REPORT. A short description of the error will be returned in Error Comment (0000,0902).

**2.2.3.3.1.5. SOP Specific Conformance for the Film Session SOP Class**

Hardcopy AE supports the following DIMSE operations for the Film Session SOP Class:

- N-CREATE
- N-DELETE

Details of the supported attributes and status handling behaviour are described in the following subsections.

**2.2.3.3.1.5.1. Film Session SOP Class Operation (N-CREATE)**

The attributes supplied in an N-CREATE Request are listed in the Table below:

**Table 2.2-31  
FILM SESSION SOP CLASS N-CREATE REQUEST ATTRIBUTES**

<b>Attribute Name</b>	<b>Tag</b>	<b>VR</b>	<b>Value</b>	<b>Presence of Value</b>	<b>Source</b>
Number of Copies	(2000,0010)	IS	1 ..	ALWAYS	USER
Print Priority	(2000,0020)	CS		ALWAYS	AUTO
Medium Type	(2000,0030)	CS		ALWAYS	AUTO
Film Destination	(2000,0040)	CS		ALWAYS	AUTO

The behavior of Hardcopy AE when encountering status codes in a N-CREATE response is summarized in the Table below:

**Table 2.2-32**

**FILM SESSION SOP CLASS N-CREATE RESPONSE STATUS HANDLING BEHAVIOR**

<b>Service Status</b>	<b>Further Meaning</b>	<b>Error Code</b>	<b>Reasons</b>
Success	Success	0000	The SCP has completed the operation successfully.
*	*	Any other status code.	The Association is released using A-RELEASE and the print-job is marked as failed. The status meaning is logged and reported to the user.

**2.2.3.3.1.5.2. Film Session SOP Class Operation (N-DELETE)**

The behavior of Hardcopy AE when encountering status codes in a N-DELETE response is summarized in the Table below:

**Table 2.2-33**

**FILM SESSION SOP CLASS N-DELETE RESPONSE STATUS HANDLING BEHAVIOR**

<b>Service Status</b>	<b>Further Meaning</b>	<b>Error Code</b>	<b>Reasons</b>
Success	Success	0000	The SCP has completed the operation successfully.
*	*	Any other status code.	The Association is released using A-RELEASE and the print-job is marked as failed. The status meaning is logged and reported to the user.

**2.2.3.3.1.6. SOP Specific Conformance for the Film Box SOP Class**

Hardcopy AE supports the following DIMSE operations for the Film Box SOP Class:

- N-CREATE
- N-ACTION

Details of the supported attributes and status handling behaviour are described in the following subsections.

**2.2.3.3.1.6.1. Film Box SOP Class Operation (N-CREATE)**

The attributes supplied in an N-CREATE Request are listed in the Table below:

**Table 2.2-34  
FILM BOX SOP CLASS N-CREATE REQUEST ATTRIBUTES**

<b>Attribute Name</b>	<b>Tag</b>	<b>VR</b>	<b>Value</b>	<b>Presence of Value</b>	<b>Source</b>
Image Display Format	(2010,0010)	ST	From user input	ALWAYS	USER
Film Orientation	(2010,0040)	CS	From user input	ALWAYS	USER
Film Size ID	(2010,0050)	CS	From user input	ALWAYS	USER
Magnification Type	(2010,0060)	CS	From Configuration	ALWAYS	AUTO
Smoothing Type	(2010,0080)	CS	From Configuration	ALWAYS	AUTO
Border Density	(2010,0100)	CS	From Configuration	ALWAYS	AUTO
Empty Image Density	(2010,0110)	CS	From Configuration	ALWAYS	AUTO
Trim	(2010,0140)	CS	From Configuration	ALWAYS	AUTO
Configuration Information	(2010,0150)	CS	From Configuration	ALWAYS	AUTO
Referenced Film Session Sequence	(2010,0500)	SQ		ALWAYS	AUTO
>Referenced SOP Class UID	(0008,1150)	UI		ALWAYS	AUTO
>Referenced SOP Instance UID	(0008,1155)	UI		ALWAYS	AUTO

The behavior of Hardcopy AE when encountering status codes in a N-CREATE response is summarized in the Table below:

**Table 2.2-35**

**FILM BOX SOP CLASS N-CREATE RESPONSE STATUS HANDLING BEHAVIOR**

<b>Service Status</b>	<b>Further Meaning</b>	<b>Error Code</b>	<b>Reasons</b>
Success	Success	0000	The SCP has completed the operation successfully.
*	*	Any other status code.	The Association is released using A-RELEASE and the print-job is marked as failed. The status meaning is logged and reported to the user.

**2.2.3.3.1.6.2. Film Box SOP Class Operation (N-ACTION)**

An N-ACTION Request is issued to instruct the Print SCP to print the contents of the Film Box. The Action Reply argument in an N-ACTION response is not evaluated.

The behavior of Hardcopy AE when encountering status codes in a N-ACTION response is summarized in the Table below:

**Table 2.2-36**

**FILM BOX SOP CLASS N-ACTION RESPONSE STATUS HANDLING BEHAVIOR**

<b>Service Status</b>	<b>Further Meaning</b>	<b>Error Code</b>	<b>Reasons</b>
Success	Success	0000	The SCP has completed the operation successfully. The film has been accepted for printing.
*	*	Any other status code.	The Association is released using A-RELEASE and the print-job is marked as failed. The status meaning is logged and reported to the user.

### 2.2.3.3.1.7. SOP Specific Conformance for the Image Box SOP Class

Hardcopy AE supports the following DIMSE operations for the Image Box SOP Class:

- N-SET

Details of the supported attributes and status handling behaviour are described in the following subsections.

#### 2.2.3.3.1.7.1. Image Box SOP Class Operation (N-SET)

The attributes supplied in an N-SET Request are listed in the Table below:

**Table 2.2-37  
IMAGE BOX SOP CLASS N-SET REQUEST ATTRIBUTES**

Attribute Name	Tag	VR	Value	Presence of Value	Source
Image Box Position	(2020,0010)	US	Depends on image position	ALWAYS	AUTO
Basic Grayscale Image Sequence	(2020,0110)	SQ		ALWAYS	AUTO
>Samples Per Pixel	(0028,0002)	US	“1”	ALWAYS	AUTO
>Photometric Interpretation	(0028,0004)	CS	“MONOCHROME2”	ALWAYS	AUTO
>Rows	(0028,0010)	US	Depends on image size	ALWAYS	AUTO
>Columns	(0028,0011)	US	Depends on image size	ALWAYS	AUTO
>Bits Allocated	(0028,0100)	US	From Configuration	ALWAYS	AUTO
>Bits Stored	(0028,0101)	US	From Configuration	ALWAYS	AUTO
>High Bit	(0028,0102)	US	From Configuration	ALWAYS	AUTO
>Pixel Representation	(0028,0103)	US	“0”	ALWAYS	AUTO
>Pixel Data	(7FE0,0010)	OW	Pixels of rendered image	ALWAYS	AUTO

The behavior of Hardcopy AE when encountering status codes in a N-SET response is summarized in the Table below:

**Table 2.2-38**

**IMAGE BOX SOP CLASS N-SET RESPONSE STATUS HANDLING BEHAVIOR**

<b>Service Status</b>	<b>Further Meaning</b>	<b>Error Code</b>	<b>Reasons</b>
Success	Success	0000	The SCP has completed the operation successfully. Image successfully stored in Image Box.
*	*	Any other status code.	The Association is released using A-RELEASE and the print-job is marked as failed. The status meaning is logged and reported to the user.

## **2.3. NETWORK INTERFACES**

### **2.3.1. Physical Network Interface**

The SDR-120 supports a single network interface. One of the following physical network interfaces will be available depending on installed hardware options:

**Table 2.3-1**

#### **SUPPORTED PHYSICAL NETWORK INTERFACES**

Ethernet 1000baseT
Ethernet 100base-TX
Ethernet 10baseT

### **2.3.2. IPv4 and IPv6 Support**

This product only supports IPv4 connections.

## 2.4. CONFIGURATION

### 2.4.1. AE Title/Presentation Address Mapping

#### 2.4.1.1. Local AE Titles

All local applications use the AE Titles and TCP/IP Ports configured via the Service Tool. The default AE Titles is listed below.

**Table 2.4-1**  
**AE TITLE CONFIGURABLE TABLE**

<b>Application Entity</b>	<b>Default AE Title</b>	<b>Default TCP/IP Port</b>
Storage	SDR120_StoreSCU	
Workflow	MWM	SDR120_MwmSCU
	MPPS	SDR120_MppsSCU
Hardcopy	SDR120_PrintSCU	

#### 2.4.1.2. Remote AE Title/Presentation Address Mapping

The AE Title, host names and port numbers of remote applications are configured using the SDR-120 Service Tool.

##### 2.4.1.2.1. Storage

The SDR-120 Service Tool must be used to set the AE Titles, port-numbers, host-names and capabilities for the remote Storage SCPs. Associations will only be accepted from known AE Titles and associations from unknown AE Titles will be rejected (an AE Title is known if it can be selected within the Service Tool). Multiple remote Storage SCPs can be defined.

##### 2.4.1.2.2. Workflow

The SDR-120 Service Tool must be used to set the AE Titles, port-numbers, host-names and capabilities of the remote Modality Worklist SCPs. Even though multiple remote Workflow SCPs can be defined, only one SCP can be selected at a time. The SDR-120 will open an association to the SCP selected in the user interface.

The SDR-120 Service Tool must be used to set the AE Title, port-number, host-name and capabilities of the remote MPPS SCP. Only a single remote MPPS SCP can be defined.

##### 2.4.1.2.3. Hardcopy

The SDR-120 Service Tool must be used to set the AE Titles, port-numbers, host-names and capabilities for the remote Print SCPs. Multiple remote Print SCPs can be defined.



## 2.4.2. Parameters

A large number of parameters related to acquisition and general operation can be configured using the Service Tool. The Table below only shows those configuration parameters relevant to DICOM communication. See the SDR-120 Service Manual for details on general configuration capabilities.

**Table 2.4-2  
CONFIGURATION PARAMETERS TABLE**

Parameter	Configurable (Yes/No)	Default Value
<b>General Parameters</b>		
PDU Size	Yes	16kB
Time-out waiting for acceptance or rejection Response to an Association Open Request. (Application Level timeout)	No	None
General DIMSE level time-out values	No	None
Time-out waiting for response to TCP/IP connect() request. (Low-level timeout)	No	None
Time-out waiting for acceptance of a TCP/IP message over the network. (Low-level timeout)	No	None
Time-out for waiting for data between TCP/IP packets.(Low-level timeout)	No	None
Any changes to default TCP/IP settings, such as configurable stack parameters.	No	None

### 3. MEDIA INTERCHANGE

#### 3.1. IMPLEMENTATION MODEL

##### 3.1.1. Application Data Flow

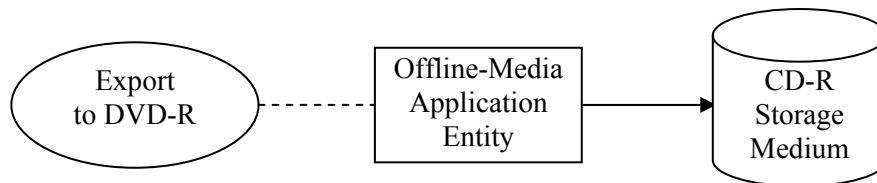

**Figure 3.1-1 APPLICATION DATA FLOW DIAGRAM FOR MEDIA STORAGE**

The Offline-Media Application Entity exports images to a DVD-R Storage medium. It is associated with the local real-world activity “Export to DVD-R”. “Export to DVD-R” is performed upon user request for selected patients, studies, series, or images.

##### 3.1.2. Functional Definition of AE’s

###### 3.1.2.1. Functional Definition of Offline-Media Application Entity

Activation of the “Export to DVD-R” menu entry will pass the currently selected patients, studies, series or images to the Offline-Media Application Entity. The SCP Instances associated with the selection will be collected into one or more export jobs. The contents of each export job will be written to a single DVD-R media.

##### 3.1.3. Sequencing of Real-World Activities

At least one image must exist and be selected before the Offline-Media Application Entity can be invoked. The operator can insert a new DVD-R media at any time before or after invocation of the Offline-Media Application Entity. The Offline-Media Application Entity will wait indefinitely for a media to be inserted before starting to write to the DVD-R device. If no DVD-R media is available the export job can be canceled from the job queue.

##### 3.1.4. File Meta Information Options

The implementation information written to the File Meta Header in each file is:

**Table 3.1-1**

**DICOM IMPLEMENTATION CLASS AND VERSION FOR MEDIA STORAGE**

Implementation Class UID	1.2.392.200036.9110.1.0.6711.2001002
Implementation Version Name	SPF XX (XX : version number)

## 3.2. AE SPECIFICATIONS

### 3.2.1. Offline-Media Application Entity Specification

The Offline-Media Application Entity provides standard conformance to the Media Storage Service Class. The Application Profiles and roles are listed below:

Table 3.2-1

#### APPLICATION PROFILES, ACTIVITIES AND ROLES FOR OFFLINE-MEDIA

Application Profiles Supported	Real World Activity	Role	
STD-GEN-CD	Export to CD-R	FSC	

#### 3.2.1.1. File Meta Information for the Application Entity

The Source Application Entity Title included in the File Meta Header is fixed (see section 3.4).

#### 3.2.1.2. Real-World Activities

##### 3.2.1.2.1. Activity – Export to DVD-R

The Offline-Media Application Entity acts as an FSC when requested to export SOP Instances from the local database to a DVD-R medium.

A dialogue will be presented informing the user about the required / available media capacity. If the contents of the current selection do not fit on a single media selection will be canceled and ask the user to select SOP Instances again.

The user will be prompted to insert a DVD-R media which is empty or written in this system for each export job. The contents of the export job will be written together with a corresponding DICOMDIR. The user can cancel an export job in the job queue.

##### 3.2.1.2.1.1. Media Storage Application Profiles

The Offline-Media Application Entity supports the STD-GEN-CD Application Profile.

### 3.2.1.2.1.1.1. Options

The Offline-Media Application Entity supports the SOP Classes and Transfer Syntaxes listed in the Table below:

**Table 3.2-2**

**IODS, SOP CLASSES AND TRANSFER SYNTAXES FOR OFFLINEMEDIA**

<b>Information Object Definition</b>	<b>SOP Class UID</b>	<b>Transfer Syntax</b>	<b>Transfer Syntax UID</b>
Media Storage Directory Storage	1.2.840.10008.1.3.10	Explicit VR Little Endian	1.2.840.10008.1.2.1
X-Ray Radio Fluoroscopic Image Storage	1.2.840.10008.5.1.4.1.1.12.2	Explicit VR Little Endian	1.2.840.10008.1.2.1
X-Ray Angiographic Image Storage	1.2.840.10008.5.1.4.1.1.12.1	Explicit VR Little Endian	1.2.840.10008.1.2.1
X-Ray Radiation Dose SR Storage	1.2.840.10008.5.1.4.1.1.88.67	Explicit VR Little Endian	1.2.840.10008.1.2.1

### 3.3. AUGMENTED AND PRIVATE APPLICATION PROFILES

The SDR-120 does not support any augmented for private application profiles.

### 3.4. MEDIA CONFIGURATION

All local applications use the fixed AE Title listed in the Table below:

**Table 3.4-1**

**AE TITLE CONFIGURATION TABLE**

<b>Application Entity</b>	<b>Default AE Title</b>
Offline-Media	SDR120-0000000000

## 4. SUPPORT OF CHARACTER SETS

All the SDR-120 applications support the following character sets:

ISO\_IR 100 (ISO 8859-1:1987 Latin Alphabet No.1 supplementary set)

ISO 2022 IR 87 (JIS X 0208: Kanji)

ISO 2022 IR 159 (JIS X 0212: Supplementary Kanji set)

The SDR-120 will set the corresponding character set based on its configuration as listed below:

**Table 3.4-1**  
**CHARACTER SET**

<b>Configuration</b>	<b>Character Set</b>
English mode	ISO_IR 100
Japanese mode	\ISO 2022 IR 87\ISO 2022 IR 159 or ISO 2022 IR 87

## 5. SECURITY

The SDR-120 does not support any specific security measures.

It is assumed that the SDR-120 is used within a secured environment. It is assumed that a secured environment includes at a minimum:

- a. Firewall or router protections to ensure that only approved external hosts have network access to the SDR-120
- b. Firewall or router protections to ensure that the SDR-120 only has network access to approved external hosts and services.
- c. Any communication with external hosts and services outside the locally secured environment use appropriate secure network channels (e.g. such as a Virtual Private Network (VPN)).

Other network security procedures such as automated intrusion detection may be appropriate in some environments. Additional security features may be established by the local security policy and are beyond the scope of this conformance statement.

## 6. ANNEXES

### 6.1. IOD CONTENTS

#### 6.1.1. Created SOP Instances

The attributes of each IODs transmitted by the SDR-120 storage application are specified in the Table listed below:

**Table 6.1-1**  
**ATTRIBUTES FOR EACH IOD**

<b>IOD</b>	<b>Specified Table</b>
X-Ray Radio Fluoroscopic Image IOD	Table 6.1-2
X-Ray Angiographic Image IOD	Table 6.1-3
X-Ray Radiation Dose SR IOD	Table 6.1-4

The following tables use a number of abbreviations. The abbreviations used in the “Presence of Module” column are:

VNAP	Value Not Always Present (attribute sent zero length if no value is present)
ANAP	Attribute Not Always Present
ALWAYS	Always Present
EMPTY	Attribute is sent without a value

The abbreviations used in the “Source” column are:

MWL	the attribute value source Modality Worklist
USER	the attribute value source is from User input
AUTO	the attribute value is generated automatically
MPPS	the attribute value is the same as that use for Modality Performed Procedure Step
CONFIG	the attribute value source is a configurable parameter

NOTE: All dates and times are encoded in the local configured calendar and time. Date, Time and Time zone are configured using the Windows Date and Time configuration.

### 6.1.1.1. X-Ray Radio Fluoroscopic Image IOD

**Table 6.1-2  
IOD OF CREATED RF SOP INSTANCES**

<b>IE</b>	<b>Module</b>	<b>Reference</b>	<b>Presence of Module</b>
Patient	Patient	Table 6.1-5	ALWAYS
Study	General Study	Table 6.1-6	ALWAYS
	Patient Study	Table 6.1-7	ALWAYS
Series	General Series	Table 6.1-8	ALWAYS
Equipment	General Equipment	Table 6.1-10	ALWAYS
Image	General Image	Table 6.1-12	ALWAYS
	Image Pixel	Table 6.1-15	ALWAYS
	Contrast/Bolus	Table 6.1-16	ALWAYS
	Cine	Table 6.1-17	Only if Multi-frame
	Multi-frame	Table 6.1-18	Only if Multi-frame
	Frame Pointers	Table 6.1-19	Only if Multi-frame
	Mask	Table 6.1-20	Only if subtracted image
	Display Shutter	Table 6.1-21	ALWAYS
	X-Ray Image	Table 6.1-22	ALWAYS
	X-Ray Acquisition	Table 6.1-23	ALWAYS
	SOP Common	Table 6.1-26	ALWAYS

### 6.1.1.2. X-Ray Angiographic Image IOD

**Table 6.1-3  
IOD OF CREATED XA SOP INSTANCES**

<b>IE</b>	<b>Module</b>	<b>Reference</b>	<b>Presence of Module</b>
Patient	Patient	Table 6.1-5	ALWAYS
Study	General Study	Table 6.1-6	ALWAYS
	Patient Study	Table 6.1-7	ALWAYS
Series	General Series	Table 6.1-8	ALWAYS
Equipment	General Equipment	Table 6.1-10	ALWAYS
Image	General Image	Table 6.1-12	ALWAYS
	Image Pixel	Table 6.1-15	ALWAYS
	Contrast/Bolus	Table 6.1-16	ALWAYS
	Cine	Table 6.1-17	Only if Multi-frame
	Multi-frame	Table 6.1-18	Only if Multi-frame
	Frame Pointers	Table 6.1-19	Only if Multi-frame
	Mask	Table 6.1-20	Only if subtracted image
	Display Shutter	Table 6.1-21	ALWAYS
	X-Ray Image	Table 6.1-22	ALWAYS
	X-Ray Acquisition	Table 6.1-23	ALWAYS
	XA Positioner	Table 6.1-25	ALWAYS
	SOP Common	Table 6.1-26	ALWAYS



### 6.1.1.3. X-Ray Radiation Dose SR IOD

**Table 6.1-4**  
**IOD OF CREATED RDSR SOP INSTANCES**

<b>IE</b>	<b>Module</b>	<b>Reference</b>	<b>Presence of Module</b>
Patient	Patient	Table 6.1-5	ALWAYS
Study	General Study	Table 6.1-6	ALWAYS
	Patient Study	Table 6.1-7	ALWAYS
Series	SR Document Series	Table 6.1-9	ALWAYS
Equipment	General Equipment	Table 6.1-10	ALWAYS
	Enhanced General Equipment	Table 6.1-11	ALWAYS
Document	SR Document General	Table 6.1-13	ALWAYS
	SR Document Content	Table 6.1-14	ALWAYS
	SOP Common	Table 6.1-26	ALWAYS

## 6.1.1.4. Modules

### 6.1.1.4.1. Patient Module

Table 6.1-5

**PATIENT MODULE OF CREATED SOP INSTANCES**

<b>Attribute Name</b>	<b>Tag</b>	<b>VR</b>	<b>Value</b>	<b>Presence of Value</b>	<b>Source</b>
Patient's Name	(0010,0010)	PN	From Modality Worklist or user input or generated by device	ALWAYS	MWL/ USER/ AUTO
Patient ID	(0010,0020)	LO	From Modality Worklist or user input or generated by device	ALWAYS	MWL/ USER/ AUTO
Patient's Birth Date	(0010,0030)	DA	From Modality Worklist or user input	VNAP	MWL/ USER
Patient's Sex	(0010,0040)	CS	From Modality Worklist or user input	VNAP	MWL/ USER
Patient Comments	(0010,4000)	LT	From user input	VNAP	USER

**6.1.1.4.2. General Study Module**

**Table 6.1-6**

**GENERAL STUDY MODULE OF CREATED SOP INSTANCES**

<b>Attribute Name</b>	<b>Tag</b>	<b>VR</b>	<b>Value</b>	<b>Presence of Value</b>	<b>Source</b>
Study Date	(0008,0020)	DA	<yyyymmdd> format date when the study is started	ALWAYS	AUTO
Study Time	(0008,0030)	TM	<hhmmss.fff> format time when the study is started	ALWAYS	AUTO
Accession Number	(0008,0050)	SH	From Modality Worklist or user input or generated by device	VNAP	MWL/ USER/ AUTO
Referring Physician's Name	(0008,0090)	PN	From Modality Worklist or user input	VNAP	MWL/ USER
Physician(s) of Record	(0008,1048)	PN	From Modality Worklist or user input	VNAP	MWL/ USER
Name of Physician(s) Reading Study	(0008,1060)	PN	From Modality Worklist or user input	VNAP	MWL/ USER
Study Instance UID	(0020,000D)	UI	From Modality Worklist or generated by device	ALWAYS	MWL/ AUTO
Study ID	(0020,0010)	SH	From Modality Worklist or generated by device	ALWAYS	MWL/ AUTO

**6.1.1.4.3. Patient Study Module**

**Table 6.1-7**

**PATIENT STUDY MODULE OF CREATED SOP INSTANCES**

<b>Attribute Name</b>	<b>Tag</b>	<b>VR</b>	<b>Value</b>	<b>Presence of Value</b>	<b>Source</b>
Patient's Age	(0010,1010)	AS	From user input or generated by device	VNAP	USER/ AUTO
Patient's Size	(0010,1020)	DS	From Modality Worklist	VNAP	MWL
Patient's Weight	(0010,1030)	DS	From Modality Worklist	VNAP	MWL

**6.1.1.4.4. General Series Module**

**Table 6.1-8**

**GENERAL SERIES MODULE OF CREATED SOP INSTANCES**

<b>Attribute Name</b>	<b>Tag</b>	<b>VR</b>	<b>Value</b>	<b>Presence of Value</b>	<b>Source</b>
Series Date	(0008,0021)	DA	<yyyymmdd> format date when the series is created	ALWAYS	AUTO
Series Time	(0008,0031)	TM	<hhmmss.fff> format time when the series is created	ALWAYS	AUTO
Modality	(0008,0060)	CS	“RF”, “XA”	ALWAYS	USER
Series Description	(0008,103E)	LO	“”	ALWAYS	AUTO
Performing Physician’s Name	(0008,1050)	PN	From Modality Worklist or user input	VNAP	MWL/ USER
Operator’s Name	(0008,1070)	PN	From Modality Worklist or user input	VNAP	MWL/ USER
Protocol Name	(0018,1030)	LO	Name and Description of the selected Protocol	ALWAYS	USER
Series Instance UID	(0020,000E)	UI	Generated by device	ALWAYS	AUTO
Series Number	(0020,0011)	IS	Generated by device	ALWAYS	AUTO
Laterality	(0020,0060)	CS	“”	EMPTY	AUTO

**6.1.1.4.5. SR Document Series Module**

**Table 6.1-9**

**SR DOCUMENT SERIES MODULE OF CREATED SOP INSTANCES**

<b>Attribute Name</b>	<b>Tag</b>	<b>VR</b>	<b>Value</b>	<b>Presence of Value</b>	<b>Source</b>
Series Date	(0008,0021)	DA	<yyyymmdd> format date when the series is created	ALWAYS	AUTO
Series Time	(0008,0031)	TM	<hhmmss.fff> format time when the series is created	ALWAYS	AUTO
Modality	(0008,0060)	LO	“SR”	ALWAYS	AUTO
Series Description	(0008,103E)	LO	“”	ALWAYS	AUTO
Series Instance UID	(0020,000E)	UI	Generated by device	ALWAYS	AUTO
Series Number	(0020,0011)	IS	Generated by device	ALWAYS	AUTO

**6.1.1.4.6. General Equipment Module**

**Table 6.1-10**

**GENERAL EQUIPMENT MODULE OF CREATED SOP INSTANCES**

<b>Attribute Name</b>	<b>Tag</b>	<b>VR</b>	<b>Value</b>	<b>Presence of Value</b>	<b>Source</b>
Manufacturer	(0008,0070)	LO	“Shimadzu Corp.”	ALWAYS	AUTO
Institution Name	(0008,0080)	LO	From Configuration	ALWAYS	CONFIG
Institution Address	(0008,0081)	ST	From Configuration	ALWAYS	CONFIG
Station Name	(0008,1010)	SH	From Configuration	ALWAYS	CONFIG
Institution Department Name	(0008,1040)	LO	From Configuration	ALWAYS	CONFIG
Manufacturer’s Model Name	(0008,1090)	LO	“SDR-120”	ALWAYS	AUTO
Device Serial Number	(0018,1000)	LO	From Configuration	ALWAYS	CONFIG

**6.1.1.4.7. Enhanced General Equipment Module**

**Table 6.1-11**

**ENHANCED GENERAL EQUIPMENT MODULE OF CREATED SOP INSTANCES**

<b>Attribute Name</b>	<b>Tag</b>	<b>VR</b>	<b>Value</b>	<b>Presence of Value</b>	<b>Source</b>
Manufacturer	(0008,0070)	LO	“Shimadzu Corp.”	ALWAYS	AUTO
Manufacturer’s Model Name	(0008,1090)	LO	“SDR-120”	ALWAYS	AUTO
Device Serial Number	(0018,1000)	LO	From Configuration	ALWAYS	CONFIG

6.1.1.4.8. General Image Module

Table 6.1-12

GENERAL IMAGE MODULE OF CREATED SOP INSTANCES

Attribute Name	Tag	VR	Value	Presence of Value	Source
Acquisition Date	(0008,0022)	DA	<yyyymmdd> format date when the image is acquired	ALWAYS	AUTO
Content Date	(0008,0023)	DA	<yyyymmdd> format date when the image is acquired	ALWAYS	AUTO
Acquisition Time	(0008,0032)	TM	<hhmmss> format time when the image is acquired	ALWAYS	AUTO
Content Time	(0008,0033)	TM	<hhmmss> format time when the image is acquired	ALWAYS	AUTO
Acquisition Number	(0020,0012)	IS	""	ALWAYS	AUTO
Instance Number	(0020,0013)	IS	Generated by device	ALWAYS	AUTO
Image Comments	(0020,4000)	LT	""	VNAP	AUTO
Burned In Annotation	(0028,0301)	CS	"NO"	ALWAYS	AUTO

**6.1.1.4.9. SR Document General Module**

**Table 6.1-13**

**SR DOCUMENT GENERAL MODULE OF CREATED SOP INSTANCES**

<b>Attribute Name</b>	<b>Tag</b>	<b>VR</b>	<b>Value</b>	<b>Presence of Value</b>	<b>Source</b>
Content Date	(0008,0023)	DA	<yyyymmdd> format date when the image is acquired	ALWAYS	AUTO
Content Time	(0008,0033)	TM	<hhmmss> format time when the image is acquired	ALWAYS	AUTO
Performed Procedure Code Sequence	(0040,A372)	SQ	""	ALWAYS	AUTO
Instance Number	(0020,0013)	IS	Generated by device	ALWAYS	AUTO
Completion Flag	(0040,A491)	CS	"PARTIAL", "COMPLETE"	ALWAYS	AUTO
Verification Flag	(0040,A493)	CS	"UNVERIFIED"	ALWAYS	AUTO

**6.1.1.4.10. SR Document Content Module**

**Table 6.1-14**

**SR DOCUMENT CONTENT MODULE OF CREATED SOP INSTANCES**

<b>Attribute Name</b>	<b>Tag</b>	<b>VR</b>	<b>Value</b>	<b>Presence of Value</b>	<b>Source</b>
Value Type	(0040,A040)	CS	"CONTAINER"	ALWAYS	AUTO
Concept Name Code Sequence	(0040,A043)	SQ		ALWAYS	AUTO
>Code Value	(0008,0100)	SH	"113701"	ALWAYS	AUTO
>Coding Scheme Designator	(0008,0102)	SH	"DCM"	ALWAYS	AUTO
>Code Meaning	(0008<0104)	LO	"X-Ray Radiation Dose Report"	ALWAYS	AUTO
Continuity of Content	(0040,A050)	CS	"SEPARATE"	ALWAYS	AUTO

\* Refer to 6.1.1.5 for detailed information.

**6.1.1.4.11. Image Pixel Module**

**Table 6.1-15**

**IMAGE PIXEL MODULE OF CREATED SOP INSTANCES**

<b>Attribute Name</b>	<b>Tag</b>	<b>VR</b>	<b>Value</b>	<b>Presence of Value</b>	<b>Source</b>
Rows	(0028,0010)	US	“1024”	ALWAYS	AUTO
Columns	(0028,0011)	US	“1024”	ALWAYS	AUTO
Pixel Aspect Ratio	(0028,0034)	IS	“1\1”	ALWAYS	AUTO
Pixel Data	(7FE0,0010)	OW	The Pixel Data itself	ALWAYS	AUTO

**6.1.1.4.12. Contrast/Bolus Module**

**Table 6.1-16**

**CONTRAST/BOLUS MODULE OF CREATED SOP INSTANCES**

<b>Attribute Name</b>	<b>Tag</b>	<b>VR</b>	<b>Value</b>	<b>Presence of Value</b>	<b>Source</b>
Contrast/Bolus Agent	(0018,0010)	LO	“”	EMPTY	AUTO
Contrast/Bolus Start Time	(0018,1042)	TM	“”	EMPTY	AUTO

**6.1.1.4.13. Cine Module**

**Table 6.1-17**

**CINE MODULE OF CREATED SOP INSTANCES**

<b>Attribute Name</b>	<b>Tag</b>	<b>VR</b>	<b>Value</b>	<b>Presence of Value</b>	<b>Source</b>
Recommended Display Frame Rate	(0008,2144)	IS	Only if multi-frame	ANAP	AUTO
Cine Rate	(0018,0040)	IS	Only if multi-frame	ANAP	AUTO
Frame Time	(0018,1063)	DS	Only if multi-frame	ANAP	AUTO



#### 6.1.1.4.14. Multi-Frame Module

Table 6.1-18

#### MULTI-FRAME MODULE OF CREATED SOP INSTANCES

Attribute Name	Tag	VR	Value	Presence of Value	Source
Number of Frames	(0028,0008)	IS	Only if multi-frame	ANAP	AUTO

#### 6.1.1.4.15. Frame Pointers Module

Table 6.1-19

#### FRAME POINTERS MODULE OF CREATED SOP INSTANCES

Attribute Name	Tag	VR	Value	Presence of Value	Source
Representative Frame Number	(0028,6010)	US	Only if multi-frame	ANAP	AUTO

#### 6.1.1.4.16. Mask Module

Table 6.1-20

#### MASK MODULE OF CREATED SOP INSTANCES

Attribute Name	Tag	VR	Value	Presence of Value	Source
Recommended Viewing Mode	(0028,1090)	CS	“SUB”	ANAP	AUTO
Mask Subtraction Sequence	(0028,6100)	SQ	Only if subtracted image	ANAP	AUTO
>Mask Operation	(0028,6101)	CS	“AVG_SUB”	ANAP	AUTO
>Mask Frame Numbers	(0028,6110)	US	Indicate frame number of mask	ANAP	AUTO
>Mask Sub-pixel Shift	(0028,6114)	FL	Indicate pixel shift value	ANAP	AUTO

**6.1.1.4.17. Display Shutter Module**

**Table 6.1-21**

**DISPLAY SHUTTER MODULE OF CREATED SOP INSTANCES**

<b>Attribute Name</b>	<b>Tag</b>	<b>VR</b>	<b>Value</b>	<b>Presence of Value</b>	<b>Source</b>
Shutter Shape	(0018,1600)	CS	“CIRCULAR”	ALWAYS	AUTO
Center of Circular Shutter	(0018,1610)	IS	Location of the center of the circular shutter	ALWAYS	AUTO
Radius of Circular Shutter	(0018,1612)	IS	Radius of the circular shutter	ALWAYS	AUTO

**6.1.1.4.18. X-Ray Image Module**

**Table 6.1-22**

**X-RAY IMAGE MODULE OF CREATED SOP INSTANCES**

<b>Attribute Name</b>	<b>Tag</b>	<b>VR</b>	<b>Value</b>	<b>Presence of Value</b>	<b>Source</b>
Image Type	(0008,0008)	CS	Generated by device	ALWAYS	AUTO
Samples per Pixel	(0028,0002)	US	“1”	ALWAYS	AUTO
Photometric Interpretation	(0028,0004)	CS	“MONOCHROME2”	ALWAYS	AUTO
Frame Increment Pointer	(0028,0009)	AT	“(0018,1063)” Only if multi-frame	ANAP	AUTO
Bits Allocated	(0028,0100)	US	“16”	ALWAYS	AUTO
Bits Stored	(0028,0101)	US	“12”	ALWAYS	AUTO
High Bits	(0028,0102)	US	“11”	ALWAYS	AUTO
Pixel Representation	(0028,0103)	US	“0”	ALWAYS	AUTO
Pixel Intensity Relationship	(0028,1040)	CS	“LIN”	ALWAYS	AUTO
Lossy Image Compression	(0028,2110)	CS	“00”	ALWAYS	AUTO

6.1.1.4.19. X-Ray Acquisition Module

Table 6.1-23

X-RAY ACQUISITION MODULE OF CREATED SOP INSTANCES

Attribute Name	Tag	VR	Value	Presence of Value	Source
KVP	(0018,0060)	DS	From Acquisition paramaters	ALWAYS	AUTO
Field of View Shape	(0018,1147)	CS	“ROUND”	ALWAYS	AUTO
Field of View Dimension(s)	(0018,1149)	IS	Generated by device	ALWAYS	AUTO
Exposure Time	(0018,1150)	IS	From Acquisition paramaters	ALWAYS	AUTO
X-Ray Tube Current	(0018,1151)	IS	From Acquisition paramaters	ALWAYS	AUTO
Radiation Setting	(0018,1155)	CS	In case of Radiography image: “GR” In case of Fluoro Record image: “SC”	ALWAYS	AUTO
Radiation Mode	(0018,115A)	CS	In case of Radiography image: “PULSED” In case of Fluoro Record image: “CONTINUOUS”	ALWAYS	AUTO
Image and Fluoroscopy Area Dose Product	(0018,115E)	DS	From Acquisition parameters	ALWAYS	AUTO
Exposure Time in uS	(0018,8150)	DS	From Acquisition parameters	ALWAYS	AUTO
X-Ray Tube Current in uA	(0018,8151)	DS	From Acquisition parameters	ALWAYS	AUTO
Pixel Spacing	(0028,0030)	DS	Calculated by calibration measurement	ANAP	AUTO

**6.1.1.4.20. X-Ray Acquisition Dose Module**

**Table 6.1-24**

**X-RAY ACQUISITION DOSE MODULE OF CREATED SOP INSTANCES**

<b>Attribute Name</b>	<b>Tag</b>	<b>VR</b>	<b>Value</b>	<b>Presence of Value</b>	<b>Source</b>
KVP	(0018,0060)	DS	From Acquisition parameters	ALWAYS	AUTO
Exposure Time	(0018,1150)	IS	From Acquisition parameters	ALWAYS	AUTO
X-Ray Tube Current	(0018,1151)	IS	From Acquisition parameters	ALWAYS	AUTO
Image and Fluoroscopy Area Dose Product	(0018,115E)	DS	From Acquisition parameters	ALWAYS	AUTO
Exposure Time in uS	(0018,8150)	DS	From Acquisition parameters	ALWAYS	AUTO
X-Ray Tube Current in uA	(0018,8151)	DS	From Acquisition parameters	ALWAYS	AUTO

**6.1.1.4.21. XA Positioner Module**

**Table 6.1-25**

**XA POSITIONER MODULE OF CREATED SOP INSTANCES**

<b>Attribute Name</b>	<b>Tag</b>	<b>VR</b>	<b>Value</b>	<b>Presence of Value</b>	<b>Source</b>
Distance Source to Detector	(0018,1110)	DS	From Configuration	ALWAYS	CONFIG
Distance Source to Patient	(0018,1111)	DS	""	ALWAYS	AUTO
Estimated Radiographic Magnification Factor	(0018,1114)	DS	""	ALWAYS	AUTO
Positioner Motion	(0018,1500)	CS	""	ALWAYS	AUTO
Positioner Primary Angle	(0018,1510)	DS	""	ALWAYS	AUTO
Positioner Secondary Angle	(0018,1511)	DS	""	ALWAYS	AUTO

6.1.1.4.22. SOP Common Module

Table 6.1-26

SOP COMMON MODULE OF CREATED SOP INSTANCES

Attribute Name	Tag	VR	Value	Presence of Value	Source
Specific Character Set	(0008,0005)	CS	In Japanese Mode: “\ISO 2022 IR 87\ISO 2022 IR 159” In English Mode: “ISO_IR 100”	ALWAYS	AUTO
SOP Class UID	(0008,0016)	UI	“1.2.840.10008.5.1.4.1.1.12.2” “1.2.840.10008.5.1.4.1.1.12.1” “1.2.840.10008.5.1.4.1.1.88.67”	ALWAYS	AUTO
SOP Instance UID	(0008,0018)	UI	Generated by device	ALWAYS	AUTO

## 6.1.1.5. X-Ray Radiation Dose Report

### 6.1.1.5.1. Template Structure

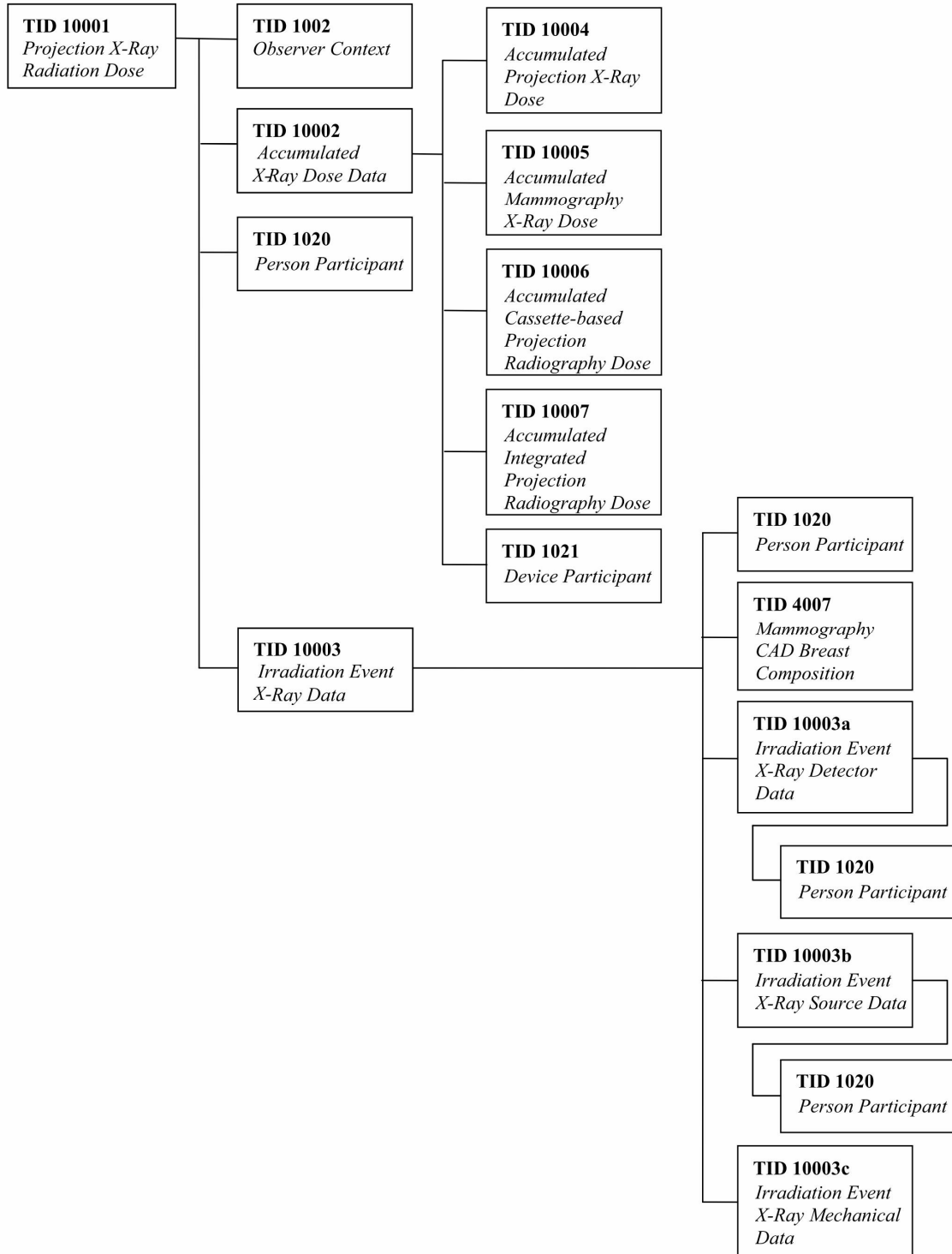

6.1.1.5.2. Projection X-Ray Radiation Dose (TID10001)

Table 6.1-27

PROJECTION X-RAY RADIATION DOSE INFORMATIONS

NL	Rel with Parent	VT	Concept Name	Value	Presence of Value	Source
		CONTAINER	EV(113701, DCM, "X-Ray Radiation Dose Report")		ALWAYS	AUTO
>	HAS CONCEPT MOD	CODE	EV(121058, DCM, "Procedure reported")	EV(113704, DCM, "Projection X-Ray")	ALWAYS	AUTO
>>	HAS CONCEPT MOD	CODE	EV(G-C0E8, SRT, "Has Intent")	EV(R-408C3, SRT, "Diagnostic Intent")	ALWAYS	AUTO
>			DTID(1002) Observer Context	Table 6.1-333	ALWAYS	AUTO
>	HAS OBS CONTEXT	CODE	EV(113705, DCM, "Scope of Accumulation")	EV(113015, DCM, "Series")	ALWAYS	AUTO
>>	HAS PROPERTIES	UIDREF		EV(112002, DCM, UID generated by device)	ALWAYS	AUTO
>	CONTAINS	CODE	EV (113945, DCM, "X-Ray Detector Data Available")	EV(R-0038D, SRT, Yes)	ALWAYS	AUTO
>	CONTAINS	CODE	EV (113943, DCM, "X-Ray Source Data Available")	EV(R-0038D, SRT, Yes)	ALWAYS	AUTO
>	CONTAINS	CODE	EV (113944, DCM, "X-Ray Mechanical Data Available")	EV(R-0038D, SRT, Yes)	ALWAYS	AUTO
>			DTID(10002) Accumulated X-Ray Dose	Table 6.1-28	ALWAYS	AUTO

NL	Rel with Parent	VT	Concept Name	Value	Presence of Value	Source
			DTID(10003) Irradiation Event X-Ray Data	Table 6.1-29	ALWAYS	AUTO
>	CONTAINS	CODE	EV(113854, DCM, "Source of Dose Information")	EV(A-2C090, SRT, "Dosimeter")	ALWAYS	AUTO



6.1.1.5.3. Accumulated X-Ray Dose (TID10002)

Table 6.1-28

ACCUMULATED X-RAY DOSE INFORMATIONS

NL	Rel with Parent	VT	Concept Name	Value	Presence of Value	Source
		CONTAINER	EV(113702, DCM, "Accumulated X-Ray Dose Data")		ALWAYS	AUTO
>	HAS CONCEPT MOD	CODE	EV(113764, DCM, "Acquisition Plane")	EV(113622, DCM, "Single Plane")	ALWAYS	AUTO
>	CONTAINS	CONTAINER	EV(122505, DCM, "Calibration")		ALWAYS	AUTO
>>	HAS CONCEPT MOD	CODE	EV(113794, DCM, "Dose Measurement Device")	EV(A-2C090, SRT, "Dosimeter")	ALWAYS	AUTO
>>	CONTAINS	DATETIME	EV(113723, DCM, "Calibration Date")	EV(113723, DCM, <yyyymmddhhmms> format date when calibration is performed)	ALWAYS	AUTO
>>	CONTAINS	NUM	EV(122322, DCM, "Calibration Factor")	EV(1, UCUM,, "no units") From Configuration	ALWAYS	CONFIG
>>	CONTAINS	NUM	EV(113763, DCM, "Calibration Uncertainty")	EV(1, UCUM, "Percent") From Configuration	ALWAYS	CONFIG
>>	CONTAINS	TEXT	EV(113724, DCM, "Calibration Responsible Party")	EV(113724, DCM, "Shimadzu Corp.")	ALWAYS	AUTO
>			DTID(10004) Accumulated Projection X-Ray Dose	Table 6.1-322	ALWAYS	AUTO

6.1.1.5.4. Irradiation Event X-Ray Data (TID10003)

Table 6.1-29

IRRADIATION EVENT X-RAY DATA INFORMATIONS

NL	Rel with Parent	VT	Concept Name	Value	Presence of Value	Source
		CONTAINER	EV(113706, DCM, "Irradiation Event X-Ray Data")		ALWAYS	AUTO
>	HAS CONCEPT MOD	CODE	EV(113764, DCM, "Acquisition Plane")	EV(113622, DCM, "Single Plane")	ALWAYS	AUTO
>	CONTAINS	UIDREF	EV(113769, DCM, "Irradiation Event UID")	DCID(10002) Irradiation Event Type UID generated by device	ALWAYS	AUTO
>	CONTAINS	DATETIME	DT(111526, DCM, "Date Time Started")	EV(111526, DCM, <yyyymmddhhmms> format date when irradiation is started)	ALWAYS	AUTO
>	CONTAINS	CODE	EV(113721, DCM, "Irradiation Event Type")	In case of Radiography: EV(113611, DCM, "Stationary Acquisition") In case of Fluoro; EV(P5-06000, SRT, "Fluoroscopy")	ALWAYS	AUTO
>	CONTAINS	TEXT	EV(125203, DCM, "Acquisition Protocol")	EV(125203, DCM, ".*") (* In case of: SPOT SPOT SERIAL SERIAL DSA DSA FILM FILM Fluoro FLUORO	ALWAYS	AUTO

NL	Rel with Parent	VT	Concept Name	Value	Presence of Value	Source
>	CONTAINS	CODE	EV(123014, DCM, "Target Region")	DCID(4031) Common Anatomic Regions ID of the target "SRT" Name of the target	ALWAYS	USER
>	CONTAINS	NUM	EV(122130, DCM, "Dose Area Product")	EV(Gy.m2, UCUM, "Gy.m2") Dose Area Product of this irradiation	ALWAYS	AUTO
>			DTID (10003a) Irradiation Event X-Ray Detector Data	Table 6.1-2830	ALWAYS	AUTO
>			DTID (10003b) Irradiation Event X-Ray Source Data	Table 6.1-2831	ALWAYS	AUTO

**6.1.1.5.5. Irradiation Event X-Ray Detector Data**

**Table 6.1-30**

**IRRADIATION EVENT X-RAY DETECTOR DATA INFORMATIONS**

<b>NL</b>	<b>Rel with Parent</b>	<b>VT</b>	<b>Concept Name</b>	<b>Value</b>	<b>Presence of Value</b>	<b>Source</b>
>	CONTAINS	IMAGE	EV(113795, DCM, "Acquired Image")	SOP Instance UID generated by device	In case of Radiography	AUTO

6.1.1.5.6. Irradiation Event X-Ray Source Data

Table 6.1-311

IRRADIATION EVENT X-RAY SOURCE DATA INFORMATIONS

NL	Rel with Parent	VT	Concept Name	Value	Presence of Value	Source
>	CONTAINS	NUM	EV(113738, DCM, "Dose (RP)")	EV(Gy, UCUM, "Gy") Air Kerma of this irradiation	ALWAYS	AUTO
>	CONTAINS	CODE	EV(113780, DCM, "Reference Point Definition")	EV(113860, DCM, "15cm from Isocenter toward Source")	ALWAYS	AUTO
>	CONTAINS	CODE	EV(113732, DCM, "Fluoro Mode")	In case of Continuous Fluoro: EV(113630, DCM, "Continuous") In case of Pulse Fluoro; EV(113631, DCM, "Pulsed")	ALWAYS	AUTO
>	CONTAINS	NUM	EV(113791, DCM, "Pulse Rate")	In case of Pulse Fluoro; EV({pulse}/s, UCUM, "pulse/s")	ALWAYS	AUTO
>	CONTAINS	NUM	EV(113768, DCM, "Number of Pulses")	EV(1, UCUM, "no units") Total number of pulses of this irradiation	ALWAYS	AUTO
>>	HAS CONCEPT MOD	CODE	EV(121401, DCM, "Derivation")	EV(R-10260, SRT, "Estimated")	ALWAYS	AUTO
>	CONTAINS	NUM	EV(113733, DCM, "KVP")	EV(kV, UCUM, "kV") Kilo-voltage of this irradiation	ALWAYS	AUTO
>	CONTAINS	NUM	EV(113734, DCM, "X-Ray Tube Current")	EV(mA, UCUM, "mA") Tube current of this irradiation	ALWAYS	AUTO

<b>NL</b>	<b>Rel with Parent</b>	<b>VT</b>	<b>Concept Name</b>	<b>Value</b>	<b>Presence of Value</b>	<b>Source</b>
>	CONTAINS	NUM	EV(113735, DCM, "Exposure Time")	EV(ms, UCUM, "ms") Exposure time of this irradiation	ALWAYS	AUTO
>			DTID(1021) Device Participant	Table 6.1-2830	ALWAYS	AUTO

**6.1.1.5.7. Accumulated Projection X-Ray Dose (TID10004)**  
**Table 6.1-322**

**ACCUMULATED PROJECTION X-RAY DOSE INFORMATIONS**

<b>NL</b>	<b>Rel with Parent</b>	<b>VT</b>	<b>Concept Name</b>	<b>Value</b>	<b>Presence of Value</b>	<b>Source</b>
	CONTAINS	NUM	EV(113722, DCM, "Dose Area Product Total")	EV(Gy.m2, UCUM, "Gy.m2") Total Dose Area Product in the study	ALWAYS	AUTO
	CONTAINS	NUM	EV(113725, DCM, "Dose (RP) Total")	EV(Gy, UCUM, "Gy") Total Air Kerma in the study	ALWAYS	AUTO
	CONTAINS	NUM	EV(113726, DCM, "Fluoro Dose Area Product Total")	EV(Gy.m2, UCUM, "Gy.m2") Total Fluoro Dose Area Product in the study	ALWAYS	AUTO
	CONTAINS	NUM	EV(113728, DCM, "Fluoro Dose (RP) Total")	EV(Gy, UCUM, "Gy") Total Fluoro Air Kerma in the study	ALWAYS	AUTO
	CONTAINS	NUM	EV(113730, DCM, "Total Fluoro Time")	EV(s, UCUM, "s") Total Fluoro Time in the study	ALWAYS	AUTO
	CONTAINS	NUM	EV(113727, DCM, "Acquisition Dose Area Product Total")	EV(Gy.m2, UCUM, "Gy.m2") Total Rad Dose Area Product in the study	ALWAYS	AUTO
	CONTAINS	NUM	EV(113729, DCM, "Acquisition Dose (RP) Total")	EV(Gy, UCUM, "Gy") Total Rad Air Kerma in the study	ALWAYS	AUTO
	CONTAINS	NUM	EV(113855, DCM, "Total Acquisition Time")	EV(s, UCUM, "s") Total Rad time in the study	ALWAYS	AUTO
	CONTAINS	NUM	EV(113731, DCM, "Total Number of Radiographic Frames")	EV(1, UCUM, "no unit") Total number of frames acquired in the study	ALWAYS	AUTO

NL	Rel with Parent	VT	Concept Name	Value	Presence of Value	Source
	CONTAINS	CODE	EV(113780, DCM, "Reference Point Definition")	DCID(10025) Radiation Dose Reference Points "15cm from Isocenter toward Source"	ALWAYS	AUTO

**6.1.1.5.8. Observer Context (TID1002)**

**Table 6.1-333**

**OBSERVER CONTEXT INFORMATIONS**

NL	Rel with Parent	VT	Concept Name	Value	Presence of Value	Source
	HAS OBS CONTEXT	CODE	EV(121005, DCM, "Observer Type")	EV(121012, DCM, "Device")	ALWAYS	AUTO
			DTID(1004) Device Observer Identifying Attributes	Table 6.1-344	ALWAYS	AUTO

**6.1.1.5.9. Device Observer Identifying Attributes (TID1004)**

**Table 6.1-344**

**DEVICE OBSERVER IDENTIFYING ATTRIBUTES INFORMATIONS**

NL	Rel with Parent	VT	Concept Name	Value	Presence of Value	Source
	HAS OBS CONTEXT	UIDREF	EV(121012, DCM, "Device Observer UID")	EV(121012, DCM, UID Generated by device)	ALWAYS	AUTO



6.1.1.5.10. Device Participant (TID1021)

Table 6.1-355

DEVICE PARTICIPANT INFORMATIONS

NL	Rel with Parent	VT	Concept Name	Value	Presence of Value	Source
		CODE	EV(113876, DCM, "Device Role in Procedure")	EV(113859, DCM, " Irradiation Device ")	ALWAYS	AUTO
>	HAS PROPERTIES	TEXT	EV(113878, DCM, "Device Manufacturer")	EV(113878, DCM, " Shimadzu Corporation ")	ALWAYS	AUTO
>	HAS PROPERTIES	TEXT	EV(113879, DCM, " Device Model Name ")	EV(113879, DCM, " Opescope Acteno ")	ALWAYS	AUTO
>	HAS PROPERTIES	TEXT	EV(113880, DCM, " Device Serial Number ")	EV(113880, DCM, Device Serial Number )	ALWAYS	AUTO
>	HAS PROPERTIES	UIDREF	EV (121012,DCM, "Device Observer UID")	EV (121012,DCM, UID Generated by device)	ALWAYS	AUTO

### 6.1.2. Used Fields in received IOD by application

The SDR-120 storage application does not receive SOP Instances. The usage of attributes received via Modality Worklist is described in section 2.2.2.3.2.3.

### 6.1.3. Attribute mapping

The relationship between attributes received via Modality Worklist, stored in acquired images and communicated via MPPS are summarized in the Table below.

**Table 6.1-366**

**ATTRIBUTE MAPPING BETWEEN MODALITY WORKLIST, IMAGE AND MPPS**

<b>Modality Worklist</b>	<b>Image IOD</b>	<b>MPPS IOD</b>
Specific Character Set	Specific Character Set	Specific Character Set
>Modality [Note 2]	Modality	Modality
>Scheduled Station AE Title [Note 2]		Performed Station AE Title
>Scheduled Performing Physician's Name [Note 2]	Performing Physician's Name	>Performing Physician's Name [Note 3]
>Scheduled Procedure Step Description [Note 2]		>Scheduled Procedure Step Description [Note 4]
		Performed Procedure Step Description
>Scheduled Protocol Code Sequence [Note 1] [Note 2]		>Scheduled Protocol Code Sequence [Note 1] [Note 4]
		Performed Protocol Code Sequence [Note 1]
>Scheduled Procedure Step ID [Note 2]		>Scheduled Procedure Step ID [Note 4]
		Performed Procedure Step ID
>Scheduled Station Name [Note 2]	Station Name	Performed Station Name
>Scheduled Procedure Step Location [Note 2]	Institution Department Name	Performed Location
Referenced Study Sequence		>Referenced Study Sequence [Note 4]

<b>Modality Worklist</b>	<b>Image IOD</b>	<b>MPPS IOD</b>
Study Instance UID	Study Instance UID	>Study Instance UID [Note 4]
Requested Procedure Description	Study Description	>Requested Procedure Description [Note 4]
Requested Procedure Code Sequence [Note 1]		Procedure Code Sequence [Note 1]
Requested Procedure ID		>Requested Procedure ID [Note 4]
Accession Number	Accession Number	Accession Number
Referring Physician's Name	Referring Physician's Name	
Patient's Name	Patient's Name	Patient's Name
Patient ID	Patient ID	Patient ID
Patient's Birth Date	Patient's Birth Date	Patient's Birth Date
Patient's Sex	Patient's Sex	Patient's Sex
Patient's Weight	Patient's Weight	
	Series Description	>Series Description [Note 3]
	Operator's Name	>Operator's Name [Note 3]
	Protocol Name	Protocol Name
	Series Instance UID	Series Instance UID
	Study ID	Study ID

[Note 1] During these attributes mapping, only the first item will be copied to MPPS IOD, even multiple items might be defined in the Worklist IOD.

[Note 2] These attributes are belonging to 'Scheduled Procedure Step Sequence (0040, 0100)'.

[Note 3] These attributes are belonging to 'Performed Series Sequence (0040, 0340)'.

[Note 4] These attributes are belonging to 'Scheduled Step Attribute Sequence (0040, 0270)'.

#### 6.1.4. Coerced/Modified Fields

The SDR-120 does not coerce/modify any attribute values received in the response to a Modality Worklist Query.

## 6.2. DATA DICTIONARY OF PRIVATE ATTRIBUTES

The Private Attributes added to created SOP Instances are listed in the Table below. The SDR-120 reserves block of private attributes in groups 6B07.

**Table 6.2-1**  
**DATA DICTIONARY OF PRIVATE ATTRIBUTES**

<b>Tag</b>	<b>Attribute Name</b>	<b>VR</b>	<b>VM</b>
(6B07,0030)	Private Creator	LO	1
(6B07,3000)	Last Modifier	UI	1
(6B07,3001)	Last Modify Date	DA	1
(6B07,3002)	Last Modify Time	TM	1

## 6.3. Coded Terminology and Templates

The Workflow AE is capable of supporting arbitrary coding scheme for Procedure and Protocol Codes. The contents of Requested Procedure Code Sequence (0032,1064) and Scheduled Protocol Code Sequence (0040,0008) supplied in Worklist items will be mapped to MPPS attributes as described in Table 6-5.

## 6.4. Grayscale Image Consistency

The high resolution display monitor attached to the SDR-120 should be adjusted by the Service Personnel during the installation.

## 6.5. Standard Extended/Specialized/Private SOP Classes

No Specialized or Private SOP Classes are supported.

## 6.6. Private Transfer Syntaxes

No Private Transfer Syntaxes are supported.